

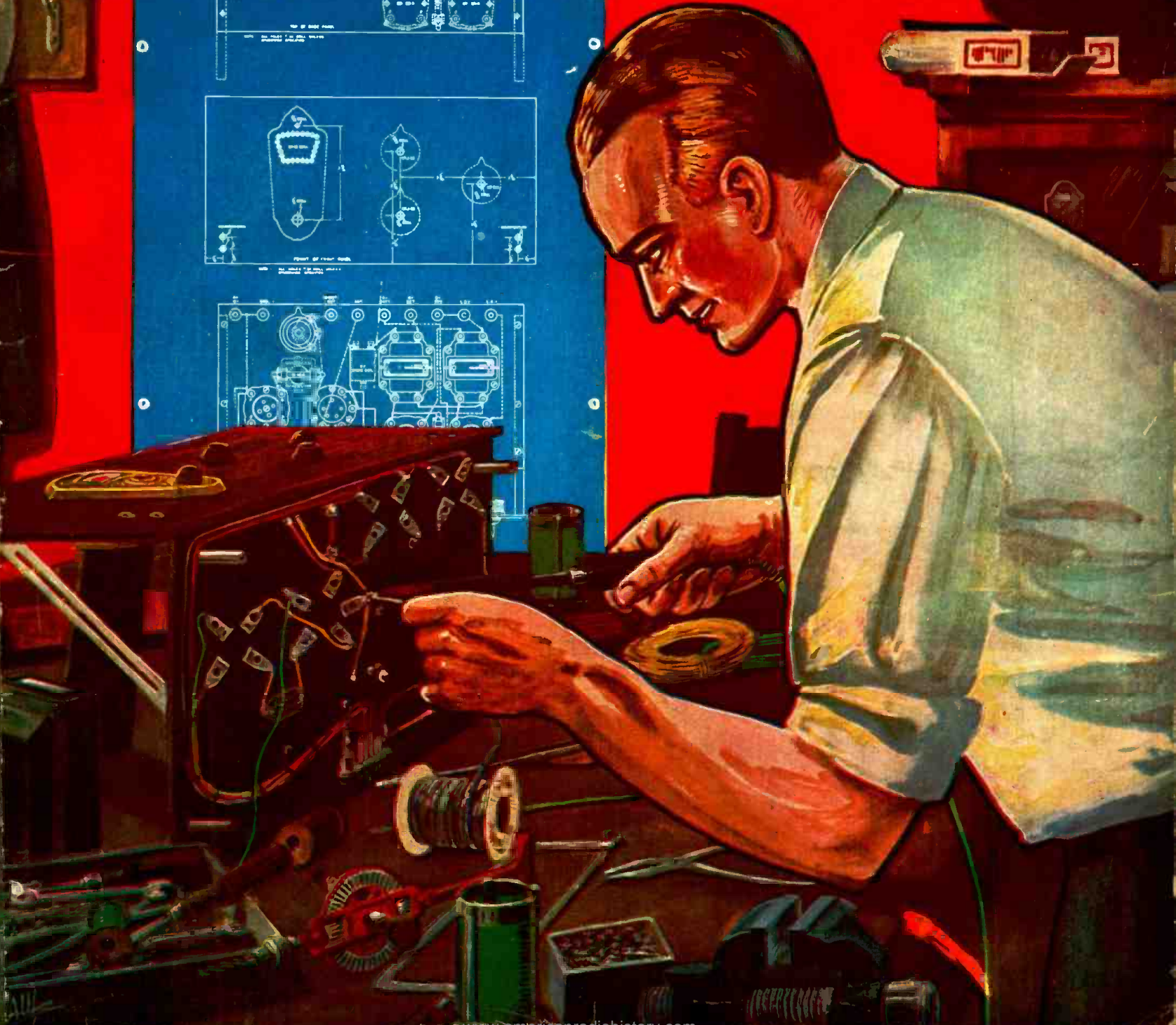

Radio-Craft

July
25 Cents

HUGO GERNSBACK Editor

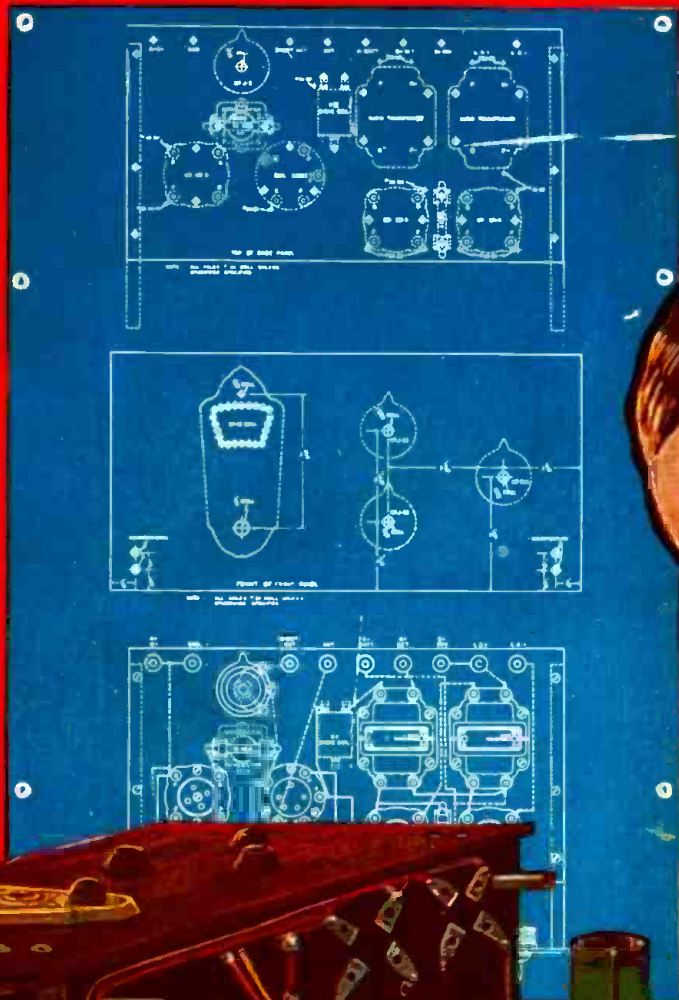

Read what BIG money these fellows have made in the RADIO BUSINESS

\$375 One Month Spare Time



"Recently I made \$375 in one month in my spare time installing, servicing, selling Radio sets. And, not so long ago, I earned enough in one week to pay for my course."
EARLE CUMMINGS,
 18 Webster St., Haverhill, Mass.

\$1597 In Five Months



"The N. R. I. is the best Radio school in the U. S. A. I have made \$1597 in five months. I shall always tell my friends that I owe my success to you."
HENRY J. NICKS, JR.,
 302 Safford Ave.,
 Tarpon Springs, Fla.

\$1164 Spare Time Profits



"Look at what I have made since I enrolled, \$1,164—money I would not have had otherwise. I am certainly glad I took up Radio with N. R. I. I am more than satisfied."
HENRY R. HEIKKINEN,
 123 W. Erie St., Chicago, Ill

Over \$1000 In Four Months



"My opinion of the N. R. I. course is that it is the best to be had at any price. When I enrolled I didn't know a condenser from a transformer, but from December to April I made well over \$1000 and I only worked in the mornings."
AL. JOHNSON,
 1109 Shelby St., Sandusky, Ohio.

I will show you too how to start a spare time or full time Radio Business of Your Own without capital



Radio's amazing growth is making many big jobs. The worldwide use of receiving sets and the lack of trained men to sell, install and service them has opened many splendid chances for spare time and full time businesses.

Ever so often a new business is started in this country. We have seen how the growth of the automobile industry, electricity and others made men rich. Now Radio is doing the same thing. Its growth has already made many men rich and will make more wealthy in the future. Surely you are not going to pass up this wonderful chance for success.

More Trained Radio Men Needed

A famous Radio expert says there are four good jobs for every man trained to hold them. Radio has grown so fast that it simply has not got the number of trained men it needs. Every year there are hundreds of fine jobs among its many branches such as broadcasting stations, Radio factories, jobbers, dealers, on board ship, commercial land stations, and many others. Many of the six to ten million receiving sets now in use are only 25% to 40% efficient. This has made your big chance for a spare time or full time business of your own selling, installing, repairing sets.

So Many Opportunities You Can Make Extra Money While Learning

Many of our students make \$10, \$20, \$30 a week extra while learning. I'll show you the plans and ideas that have proved successful for them—show you

I Will Train You At Home In Your Spare Time

I bring my training to you. Hold your job. Give me only part of your spare time. You don't have to be a college or high school graduate. Many of my graduates now making big money in Radio didn't even finish the grades. Boys 14, 15 years old and men up to 60 have finished my course successfully.

You Must Be Satisfied

I will give you a written agreement the day you enroll to refund your money if you are not satisfied with the lessons and instruction service when you complete the course. You are the only judge. The resources of the N. R. I. Pioneer and Largest Home-Study Radio school in the world stand back of this agreement.

Get My Book

Find out what Radio offers you. My 64-page book, "Rich Rewards in Radio" points out the money making opportunities the growth of Radio has made for you. Clip the coupon. Send it to me. You won't be obligated in the least.

Address

**J. E. Smith, Pres.
 Dept. 9T95**

**National Radio Institute
 Washington, D. C.**

This Book points out what Radio offers You Get a copy!



how to begin making extra money shortly after you enroll. G. W. Page, 1807-21st Ave., S., Nashville, Tenn., made \$935 in his spare time while taking my course.

I Give You Practical Radio Experience With My Course

My course is not just theory. My method gives you practical Radio experience—you learn the "how" and "why" of practically every type of Radio set made. This gives you confidence to tackle any Radio problems and shows up in your pay envelope too.

You can build 100 circuits with the Six Big Outfits of Radio parts I give you. The pictures here show only three of them. My book explains my method of giving practical training at home. Get your copy!

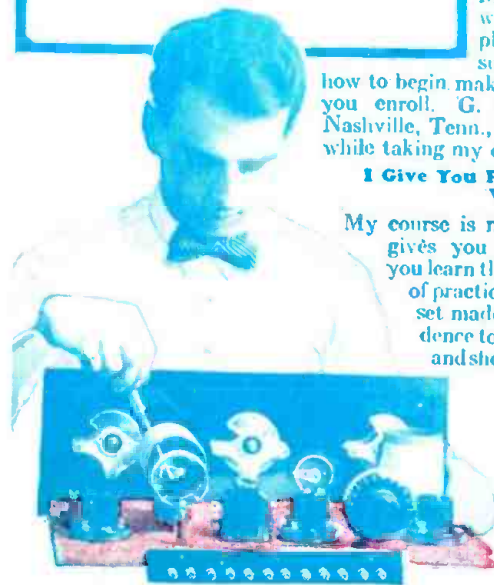

This coupon is good for a FREE copy of my Valuable Book. Mail it NOW!

J. E. Smith,
 President
 Dept., 9T95,
 National Radio Institute, Washington, D. C.

Dear Mr. Smith: Send me your book. I want to know more about the opportunities in Radio and your practical method of teaching at home in spare time. This request does not obligate me to enroll and I understand no agent will call on me.

Name..... Age.....
 Address.....
 City..... State.....

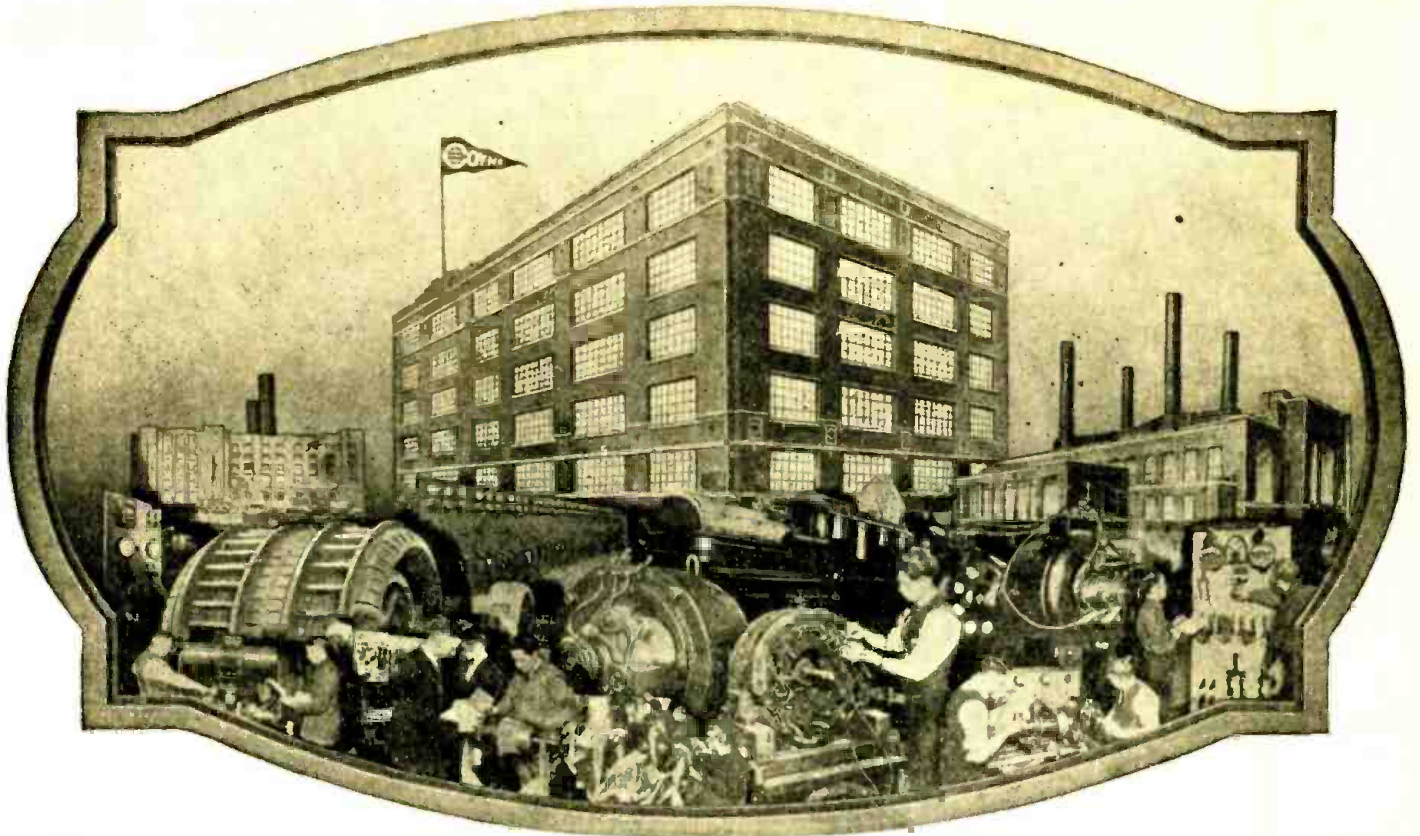

Get into ELECTRICITY

—Learn in 90 Days—Without Books

Don't spend your life waiting for \$5 raises in a dull, hopeless job. Now . . . and forever . . . say good-bye to 25 and 35 dollars a week. Let me show you how to qualify for jobs leading to salaries of \$50, \$60 and up, a week, in Electricity—NOT by correspondence, but by an amazing way to teach, that makes you a practical expert in 90 days! Getting into Electricity is far easier than you imagine! Act now, today!

NEW - Quick Amazingly Easy Method!

Lack of experience—age or advanced education bars no one. I don't care if you are 16 years old or 40. It makes no difference. Don't let lack of money stop you. Most men at Coyne have no more money than you have.

Earn While Learning

If you should need part time work, I'll assist you in getting it. Then, in 12 brief weeks in the great roaring shops of Coyne, I'll train you as you never dreamed you could be trained.

No Books

You work on real live electrical machinery, building real batteries, winding real armatures, operating real motors, dynamos and generators, wiring real houses, etc., etc.—here in this world famous parent school, with its hundreds of thousands of dollars worth of new up-to-date electrical equipment.

Jobs—Pay—Future

Don't worry about a job. Coyne training settles the job question for life. Clyde F. Hart got a position as electrician with the Great Western Railroad at over \$100.00

My Course includes **TRAINING in Aeroplane Electricity**
Not a Correspondence School

COYNE ELECTRICAL SCHOOL

H. C. LEWIS, Pres. Established 1899
500S. Paulina St., Dept. B9-95, Chicago



Prepare for Jobs Like These

Here are a few of hundreds of positions open to Coyne-trained men. Our free employment bureau gives you lifetime employment service.

- Armature Expert up to \$100 a Week
- Substation Operator up to \$85 a Week
- Auto Electrician \$60 a Week and up
- Inventor - - - Unlimited
- Maintenance Engineer up to \$100 a Week
- Service Station Owner \$50 a Week and up
- Radio Expert \$60 a Week and up

a week. That's not unusual. We can point to Coyne men making up to \$600.00 a month. Easy to get jobs leading to \$50 a week and up, while starting your own electrical business puts you in a position to become independent.

Get the Facts

Send now for my big book containing 150 photograph reproductions telling the whole Coyne story. It tells you how many earn expenses while training and all about our lifetime employment service. We are now in our new \$2,000,000 school—the finest school in the world devoted to the exclusive training in Electricity.

Coyne is your one great chance to get into electricity. Every obstacle is removed. This school is 30 years old—Coyne training is tested—proven beyond all doubt—endorsed by many large electrical concerns. You can find out everything absolutely free. Simply mail the coupon and let me send you the big, free Coyne book.

Send for Free Book!

Mr. H. C. LEWIS, Pres.
COYNE ELECTRICAL SCHOOL, Dept. B9-95
500 So. Paulina Street, Chicago, Ill.

Dear Mr. Lewis:—Without obligation send me your big free catalog and details of Free Employment Service, Aviation, Radio and Automotive Courses, and how I can "earn while learning."

Name _____
Address _____
City _____ State _____



VOLUME I.

July

NUMBER 1

HUGO GERNSBACK, Editor-in-Chief

R. D. Washburne, Technical Editor.

C. P. Mason, Associate Editor

Contents of This Issue :

	PAGE		PAGE
EDITORIAL—"THE REASON FOR RADIO-CRAFT," Hugo Gernsback	5	SHORT WAVE CRAFT	
RADIO-CRAFT CONSTRUCTOR		THE PILOT "SUPER-WASP".....	John Geloso 22
THE "SUPREME" POWER AMPLIFIER.....	6	LATEST THINGS IN RADIO.....	26
1929 "HARKNESS SCREEN GRID DE LUXE," Kenneth Harkness	10	NEW DYNAMIC SPEAKER OF SIMPLIFIED CONSTRUCTION.....	Clyde J. Fitch 31
A PORTABLE SCREEN GRID FOUR.....	16	RADIO-CRAFT KINKS.....	32
THE A.C. SCREEN GRID "SEVEN SEAS" CONSOLE, Charles R. Leutz	20	SERVICE MAN'S DATA.....	34
		INFORMATION BUREAU.....	36

In The August Issue

The Moore-Daniels Receiver..... By Alfred J. Daniels
 This article by one of the co-designers describes in detail how to build a complete radio set with which there should be no difficulty in duplicating the coast-to-coast reception record of the original model.

The Problems of Television..... By D. E. Replogle
 This is a non-technical treatment of the technicalities which constitute present day television reception and transmission, together with a consideration of the factors which control its practicability.

Cone Diaphragms and Sector Diaphragms,
 By Dr. Eugen Nesper (Berlin)
 The principles of operation and construction details of a new and desirable type of reproducer differing from others now in use, are described.

Servicing the Broadcast Receiver..... By Julius G. Aceves
 This article will interest the majority of readers of RADIO-CRAFT magazine, and the service men will be particularly appreciative of the table which appears in the article, describing the various troubles which develop in broadcast receivers, and their remedies.

RADIO-CRAFT is published on the 5th of the preceding month. 12 numbers per year, subscription price is \$2.50 a year in United States and its possessions. In Canada and foreign countries, \$3.00 a year. Single copies 25c. Address all contributions to Editor, RADIO-CRAFT, 96-98 Park Place, New York. Publishers are not responsible for lost Mss. Contributions cannot be returned unless authors remit full postage.

RADIO-CRAFT—Monthly—application for second class matter in the Postoffice of New York, under the act of March 3, 1879, pending. Title registered U. S. Patent Office. Trademarks and copyrights by permission of Gernsback Publications, Inc., 96 Park Place, New York City, owner of all trademark rights. Copyright 1929, by G. P., Inc. Text and illustrations of this magazine are copyright and must not be reproduced without permission of the copyright owners.

RADIO-CRAFT is for sale at all principal newsstands in the United States and Canada. European agents: Brentano's, London and Paris. Printed in U. S. A.
 IF YOU WISH TO SUBSCRIBE TO RADIO-CRAFT, make out all remittances to the Techni-Craft Publishing Corp., 96-98 Park Place, New York City. Be sure to mention the name of magazine you wish to subscribe for, as we are also agents for the following magazines: SCIENCE WONDER STORIES and AIR WONDER STORIES, subscription price of which is the same as RADIO-CRAFT. Subscriptions can be made in combination with the above publications, at a reduced club rate. Ask for information. Subscriptions start with current issue. WHEN YOUR SUBSCRIPTION EXPIRES, we enclose a renewal blank in the last number. No subscriptions continued unless renewal remittance received.
 Change of Address. Always give us old as well as new address and notify us as far in advance as possible.

This magazine is published by

TECHNI-CRAFT PUBLISHING CORPORATION

H. GERNSBACK, President S. GERNSBACK, Treasurer JOSEPH M. HERZBERG, Vice-President IRVING S. MANHEIMER, Secretary

Chicago Advertising Representative: L. F. McCLURE, 737 North Michigan Avenue

Editorial, Advertising and General Offices 96-98 Park Place, New York City

Radio Handbook

5 Easy Ways to Make \$3.00 an hour in Your Spare Time in RADIO

IMPROVE TONE AND VOLUME OF OLD SETS

MODERNIZE OLD SETS WITH ONE DIAL CONTROL

REDUCE STATIC BY MARVELOUS NEW METHOD

RADIO-FY & ELECTRIFY PHONOGRAPHS

Each of these plans, developed by the Radio Training Association of America, is a big money-maker. Set owners everywhere want to get rid of static, to have their sets operate from the electric light socket, the tone improved, and the volume increased, and transformed into single-dial controls. Phonograph owners want their machines electrified and radiofied. If you learn to render these services, you can easily make \$3.00 an hour for your spare time, to say nothing of the money you can make installing, servicing, repairing, building radio sets, and selling supplies.

Over \$600,000,000 is being spent yearly for sets, supplies, service. You can get your share of this business and, at the same time, fit yourself for the big-pay opportunities in Radio by joining the Association.

Join the Radio Training Association of America

A membership in the Association offers you the easiest way into Radio. It will enable you to earn \$3.00 an hour upwards in your spare time—train you to install, repair and build all kinds of sets—start you in business without capital or finance an invention—train you for the \$3,000 to \$10,000 big-pay radio positions—help secure a better position at bigger pay for you.

A membership need not cost you a cent!

The Association will give you a comprehensive, practical, and theoretical training and the benefit of its Employment Service. You earn while you learn. Our cooperative plan will make it possible for you to establish a radio store. You have the privilege of buying radio supplies at wholesale from the very first.

Earned \$500.00 Spare Time
 Frank J. Deutsch, Penn.: "I have made over \$500 out of Radio in my spare time."

Radio Engineer in One Year
 Claude De Grave, Canada: "I knew nothing about Radio when I joined a year ago. I am now a member of a very exclusive organization of Radio Engineers, and my income is 225% greater than it was."

Doubles Income in 6 Months
 W. E. Thon, Chicago: "Six months after I enrolled I secured the managership of large Radio Store and doubled my income."

ACT NOW — If You Wish the No-Cost Membership Plan

To a limited number of ambitious men, we will give Special Memberships that may not—need not—cost you a cent. To secure one, write today. We will send you details and also our Radio Handbook filled with dollars-and-cents radio ideas. It will open your eyes to the money-making possibilities of Radio.

Radio Training Association of America
 4513 Ravenswood Ave., Dept. RCA-6, Chicago, Ill.

Radio Training Association of America
 Dept. RCA-6, 4513 Ravenswood Ave., Chicago, Ill.
 Gentlemen: Please send me by return mail full details of your Special Membership Plan, and also copy of your Radio Handbook.

Name

Address

City State

SM

S-M Reduced Prices Mark a New Era Of Confidence

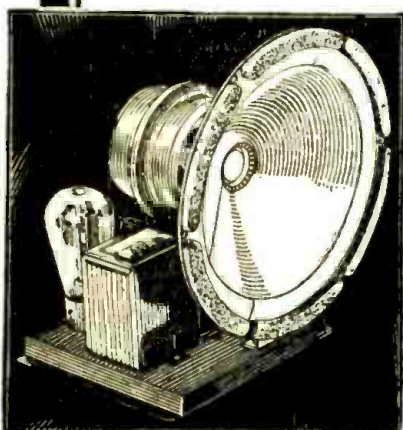

YES—

Something Happened in Speakers When the S-M Appeared

The new S-M speaker is fast becoming as famous an audio product as Silver-Marshall's immensely popular Clough-system audio transformers. So accurately designed is this new speaker unit that it eliminates all objectionable hum as well as "drummy" tones, and brings out both low and high pitches with a fidelity hitherto unobtainable. Two types: 851 for 110-volt d.c., \$29.10 net. 850, for 50-60 cycle 105-120 volt a.c. (using 1-80 tube), \$35.10 net.

FOR a long time Silver-Marshall has felt that the "list price" method of pricing prevalent in the radio parts business was not conducive to public confidence, and that it should be discarded in favor of an honest and straightforward policy. The situation today is that fully 95% of all radio parts sold go to professional setbuilders, service men or experimenters with commercial connections, who buy at a fictitious "list" price less a discount, usually about 40%. As this discount is available thru, actually, millions of mail order and jobber catalogues, to any and every buyer, the list price is indeed fictitious, and serves no purpose except to destroy confidence.

For this reason Silver-Marshall, as America's largest parts manufacturer, believes that the time has come to "clean house" in the industry—alone if necessary. Therefore, effective April 15th, all S-M list prices were reduced about 40%, so that the new list prices are now about the net prices available to all. No "dollars and cents" change is made—an outworn fiction only is discarded. Henceforth, the professional setbuilder and service man will never be embarrassed when, after selling a set, he is confronted by his customer with a net price catalog. There will be only one selling price on S-M apparatus—the new "net-list," at which consumers, setbuilders, and professional setbuilders can all buy.

This change is intended to, and will, protect service stations and professionals, who, buying parts at the same prices their customers obtain, have their profits insured by a fair and generous differential (to cover their labor) between the cost of parts to their customers and the cost of factory wired sets.

S-M believes that this frank and open policy will insure confidence among those it is designed to protect and help—the consumer, the setbuilder, the service station and jobbers, for it protects the professional from cut-price competition, consequently makes selling easier, and inspires confidence, not mistrust, in his customer.



S-M Power Amplifiers With Clough-System Tone

Operating entirely from the a.c. light socket, and using the famous S-M Clough-system audio transformers, these amplifiers give the very finest reproduction at auditorium-volume obtainable on the market today.

S-M 690, to reach 2000 or more people, has three stages (last two push-pull); supplies 6 to 12 or more dynamic speakers. Fading control on panel, and three-point switch for record—microphone—radio input selection. Uses 1-27, 2-26, 2-50, and 2-81 tubes. Price, less tubes, \$147, net.

S-M 679, to reach 1000 or more people, has two stages; supplies 2 to 4 or more dynamic speakers. Binding posts for microphone—radio—record pickup input. Uses 1-26, 1-50, 2-81 tubes. Price less tubes, \$81, net.

S-M "PA" type amplifiers are available for all larger experimental installations at surprisingly reduced prices, as shown in our new April 15th catalog.

S-M's monthly publication, *The RADIOBUILDER*, is mighty interesting reading these days. Issue No. 12 (April, 1929) contained a forecast of band selector tuning as it will characterize 1930 receivers; also a timely discussion of the "one-stage" audio trend. If you are not getting the *RADIOBUILDER*, be sure to send the coupon—and send it anyway for the new S-M April catalog, containing new low S-M list prices, which are net.

Authorized S-M Service Stations have made money this season, and still bigger opportunities are opening up for them. Ask us about the Service Station appointment.

SILVER-MARSHALL, Inc.

6419 West 65th St., Chicago, U. S. A.

Silver-Marshall, Inc.
6419 W. 65th St., Chicago, U. S. A.

.... Please send me, free, the new April S-M Catalog; also sample copy of the *RADIOBUILDER*.
For enclosed..... in stamps, send me the following.....

.... 50c. Next 12 issues of *The Radiobuilder*
.... \$1.00. Next 25 issues of *The Radiobuilder*

S-M DATA SHEETS as follows, at 2c each:

.... No. 1. 670B, 670ABC Reservoir Power Units
.... No. 2. 685 Public Address Unipac
.... No. 3. 730, 731, 732 "Round-the-World" Short Wave Sets
.... No. 4. 223, 225, 226, 256, 251 Audio Transformers
.... No. 5. 720 Screen Grid Six Receiver
.... No. 6. 740 "Coast-to-Coast" Screen Grid Four
.... No. 7. 675ABC High-Voltage Power Supply and 676 Dynamic Speaker Amplifier
.... No. 8. Sargent-Raymont Seven
.... No. 9. 678PD Phonograph Amplifier
.... No. 10. 720AC All-Electric Screen-Grid Six.
.... No. 12. 669 Power Unit (for 720AC)

Name.....

Address.....



HUGO GERNSBACK.

Editor

EDITORIAL AND GENERAL OFFICES, 96-98 PARK PLACE, NEW YORK.

The Reason For Radio-Craft

By HUGO GERNSBACK



ANOTHER new Radio Publication? In 1929?—At this late date? Why and wherefore? Aren't there enough radio publications now—most of which, as the trade well knows, are *not* successful?

The answers to these most obvious questions are quite simple.

In the first place, RADIO-CRAFT will be a strictly-specialized class publication, covering only a restricted field, namely: Radio set builders, radio constructors, short-wave fans, service men, amateurs ("hams") and Television enthusiasts. As the name of the new publication explains, RADIO-CRAFT will go *only* to those who experiment and CONSTRUCT, whether for pleasure or profit. No attempt will be made, either now or later, to cover any other radio field.

There are in the United States and Canada, as well as scattered over a number of other countries, a total of between 250,000 to 350,000 *active* radio enthusiasts, short-wave fans, radio service and repair men.

This number of radio craftsmen is quite stable, neither increasing greatly nor decreasing over a period of years. New-comers continuously fill the gaps of those who drop out of the game.

Few people—even those well versed in radio matters—realize that this condition has prevailed since 1912. That is, there have been between 250,000 and 350,000 "radio-bugs" every year since that time—long before broadcasting started. It is true that this number increased greatly from 1922 to 1925, when thousands of additional new "fans" came into being. It is this condition which confused so many newcomers, particularly radio manufacturers, because they looked upon 1922-25 conditions as standard; when they should have looked to the 1913 or 1920 barometer, which was normal, just as 1928 or 1929 is normal.

Having been a publisher of radio magazines continuously from 1908 till the present, I believe that I can talk with authority on the subject.

It is my sincere conviction that there will always be from 250,000 to 350,000 radio constructors, in one line or another.

In 1912, when I established the world's first radio magazine, "MODERN ELECTRICS," we had that many. Then it was "wireless"—in the days of the crystal detector and the spark coil.

In 1914, when I issued "THE ELECTRICAL EXPERIMENTER," the story was the same. The vacuum tube had just come on the horizon to stimulate new interest.

In 1919, when I established "RADIO NEWS," broadcasting was just about to give the radio enthusiast a tremendous impetus.

In 1929, with the birth of RADIO-CRAFT, the story still remains the same. Television, now an accomplished fact, is just ready to emerge from the laboratory. In due time it will create another "1922-1925" boom—unhealthy to be sure, but inevitable just the same.

In 1929, too, radio takes on still other new interests. New tubes—the screen-grid, for instance—and power amplification for theatres, halls, etc., have created new radio outlets. The A.C. set is still in the ascendancy. There is a small boom at present in short-wave activities.

What next year will bring, no one can foretell. But one thing remains certain—there will be from 250,000 to 350,000 radio enthusiasts who will build and buy. And so it will be in 1935 and 1940.

At any rate, I back up my belief in radio by getting out a new and better radio publication—a most difficult task, when it would be simple to get out publications in a different field.

But I have been urged by a number of radio friends and advertisers to start a *specialized* radio publication and I am doing so now; in the face of the fact that practically ALL other present radio publications are admittedly on the decline.

RADIO-CRAFT will start its life with a bona-fide circulation of over 75,000 radio readers, the second largest radio magazine circulation in America. It is my belief that, within one year, RADIO-CRAFT will have the largest circulation of all radio publications.

The editorial policy of RADIO-CRAFT will be along purely constructional and experimental lines. I quote from the circular letter sent to prospective subscribers, of the classes mentioned above:

"Contents of RADIO-CRAFT will be: The Newest Hookups; the latest things in radio; every new article and apparatus brought out; radio construction galore; service men's data; short-wave dope by the ream; a real section on questions and answers; blue-print articles in profusion—in short, you'll get a "He-Man" radio dope sheet that's chock-full of the very stuff you want, in language that's your own.

"And this is what you won't get:

"Re-hash stuff, so sadly prevalent in present-day radio magazines; pictures of the latest radio mast in Timbuctoo; stories of how Roxy killed a fly on the mike; picture gallery of radio broadcast announcers flanked by goggle-eyed sopranos; radio mathematics that are swell food for Einstein, but that give you indigestion; curves, graphs and charts of everything imaginable—glorious dope for university professors, but a total loss to you."

RADIO-CRAFT—first, last and always—will be edited solely for its readers. It is not edited for advertisers; if it were, it would and could not have a continuous reader-support and would be useless to the advertiser. *Advertising must pay*—it can do so only by giving the readers what they want and when they want it; so that *they* will be in a position, by mere strength of numbers, to adequately support the advertisers.

On the other hand, RADIO-CRAFT will go out of its way to co-operate with worthy manufacturers. If a manufacturer has a *new* set, a *new* kit, a new circuit or a new product, I want to publish it *first*. Only in that way can RADIO-CRAFT become the greatest and most widely-read radio builders' magazine.

Readers and manufacturers alike will be gratified in learning that a recent test letter mailed to over 5,000 radio builders brought back the information that 73 per cent of those replying desire to have the manufacturers' names mentioned.

Accordingly, RADIO-CRAFT will mention the names of manufacturers of all products described in its columns.

But please do not judge future issues by this one. Remember, this is a summer issue and all radio publications sell poorly during the summertime.

Future issues will contain a great deal more material than the present one.



RADIO CRAFT CONSTRUCTOR

The "Supreme" Power Amplifier

By JACK GRAND*

THE custom set builder and the experimenter will welcome the "Supreme" Power Amplifier, described in detail by Mr. Jack Grand. Four stages of audio amplification are available. The first stage is used only where the input voltage is extremely low. The first stage incorporates the '27 type tube, as does also the second stage. This is done to eliminate the hum which would result if type '26 tubes were used in these stages. Type '26 tubes are successfully used in the next stage, two in push-pull being shown. The last, or power stage, includes type '50 tubes in push-pull. With the particular arrangement shown unusual quality and volume are obtained. The volume range is from a whisper to auditorium power.

Introduction

THE tremendous popularity of the new talking and sound reproducing equipment used in conjunction with motion picture and public address systems has opened up a new field of endeavor for the man who heretofore has made a business of building

*Technical Staff, Sun Radio Co., New York City.

custom receivers and servicing standard equipment.

The comparative simplicity of the construction of an amplifier suitable for the average theater or hall lends itself to the radio man as a new source of profit.

One method of reproducing theatre music, speech or sound comprises a photo-

changes in transparency of the path on the side of the film.

Another method consists of the familiar act of reproducing the music or speech on a phonograph record and timing it to the picture.

The latter method is the most common one and is very satisfactory. The



Power amplifiers are not usually a thing of beauty. However, the balanced and efficient appearance of this panel is an inducement to construct the power plant.

electric cell which is actuated by an electric lamp placed so that the film is between the lamp and the cell. A small path on one edge of the film is used to control the amount of light reaching the cell, which has the property of conducting electric current when a beam of light is directed at it. Various light densities allow different quantities of current to flow in the cell and the light variation is obtained by the small

amplifier described here can be employed with either method with modifications for use with a photoelectric cell but is particularly adapted for use with the phonograph method of reproduction.

New records much larger in diameter than the familiar standard 12-inch disc are available and the complete musical score is recorded (ordinarily, at the time the picture is shown in the studio). These records are available to the motion picture exhibitor and are rented with the film.

Each record runs for 8 to 10 minutes and a double turntable should be employed so that as one record is ended the other record can be "faded in" and continue without changing its tempo, so that it does not lag or speed up ahead of the picture.

Controls are available which allow the pick up to be changed from one turntable to the other without noises due to the opening of electrical circuits. The changing from one record to another is termed "fading".

The turntables run at speeds of 30 to 33 R.P.M. in contrast to the 78 revolutions per minute for standard phonograph records.

Placing the Reproducers

Each theater or hall has some peculiar acoustic fault which may have to be

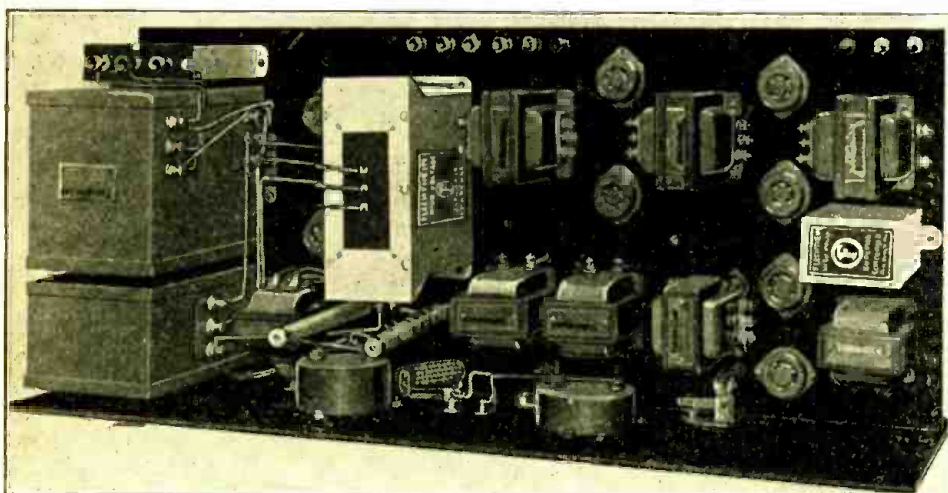

"Bird's eye" perspective of the "Supreme" Power Amplifier. The neatness is due in good part to wiring of the subpanel type. Circuit hum is eliminated by proper parts placement.

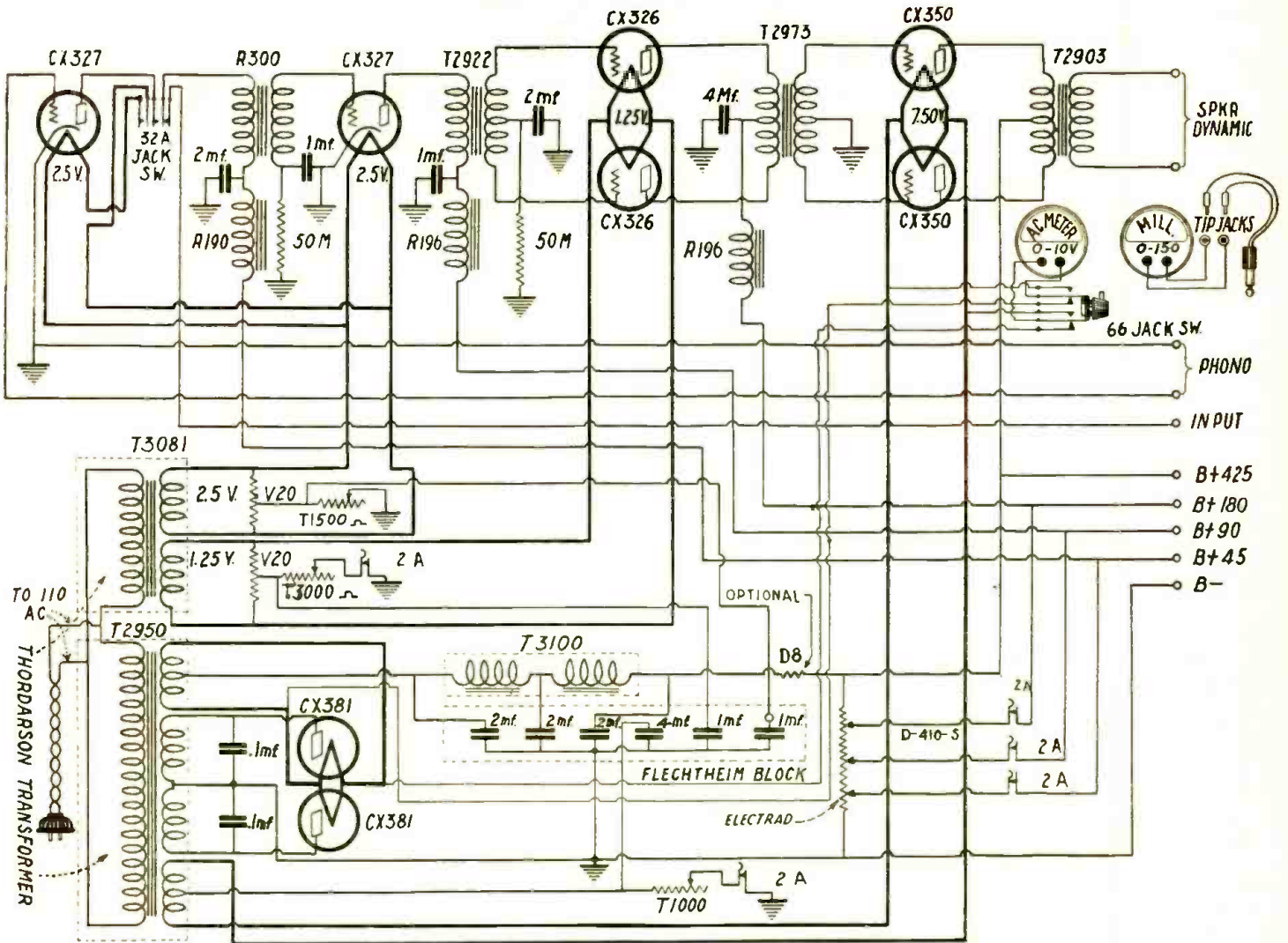

Schematic circuit of the "Supreme" Power Amplifier. The power output of the arrangement is sufficient for hall or theatre, if desired. Plenty of power is available for good loud speaker volume from weak stations, where the "noise level" of the radio-frequency and detector part of the set does not exceed the "threshold value" of the signal desired.

overcome, but on the whole good results may be obtained by placing the reproducers on the platform behind the picture screen or in the orchestra pit. The place generally giving the best results and the utmost realism is behind the screen.

The screen in this case should have the quality of reflecting the images properly and at the same time allowing the sound to come forward toward the audience.

An amplifier of this type will furnish coverage for houses with a seating capacity up to 2,500 people very satisfactorily with the correct number and placement of dynamic speakers.

Speakers of the heavy duty type are available and should be used to handle the power output of the amplifier, which will be from 12 to 15 watts of undistorted output.

The compactness of the physical design and the good engineering practice incorporated in this equipment coupled with the advantages of accessibility of tubes and other parts for replacement or repair are extremely valuable to the man who builds such equipment as well as to the theater owner who desires; and must have good service and operation at all times.

The importance of this new development in the art of entertainment is so great it is imperative that material used in the building of such an amplifier should be of the best electrical and manufacturing design and carefully tested before being installed or even assembled.

The equipment specified in the material list with this article was carefully selected by its designer and used with the consideration of quality and reliability foremost.

Description of Amplifier

The two Jewell meters are mounted on the front panel as well as the "C" bias adjustments and, with the jacks, permit determining the proper selection of the various bias voltages corresponding to the plate voltages specified by the tube manufacturer. The two tip jacks connect with the milliammeter and a cable with a plug is attached so that the various currents can be measured by

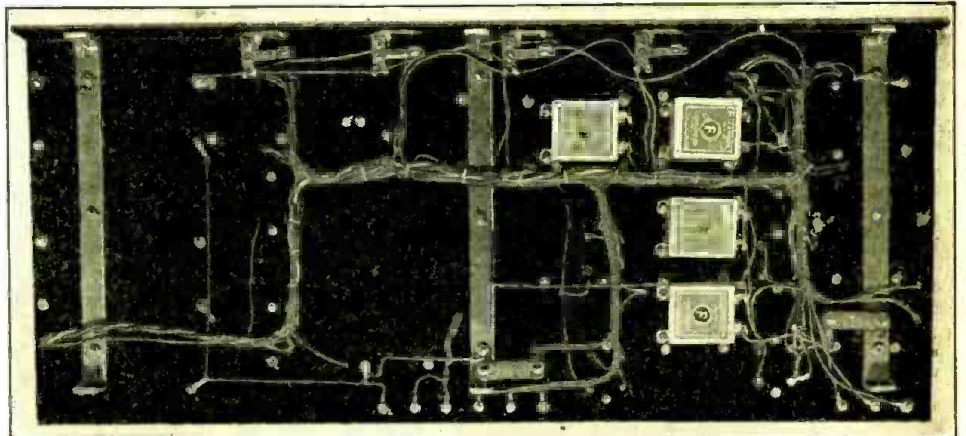

Sub-panel appearance of the power amplifier described in the text. Cabled leads increase the symmetry of appearance.

Quick SUCCESS in RADIO

**Satisfaction Guaranteed
or Money Refunded**

At last! A guaranteed method of radio training... sponsored by RCA... based on the research and discoveries made in the great RCA laboratories... a method that insures quick success in all branches of radio; manufacturing, servicing, selling, ship- and -shore broadcasting, television, photoradiograms! Radio needs you... big pay... amazing opportunities... thrilling work... adventure galore. Prepare at home through this marvelous new laboratory method! Act now... mail the coupon below for thrilling free book about this guaranteed short-cut to success in America's fastest growing profession! Radio Institute of America, Dept. R.C.7, 326 Broadway, New York, N. Y.

**Pick the job you
want and fill it
in 9 months**

SPONSORED BY



**RADIO INSTITUTE
OF AMERICA**

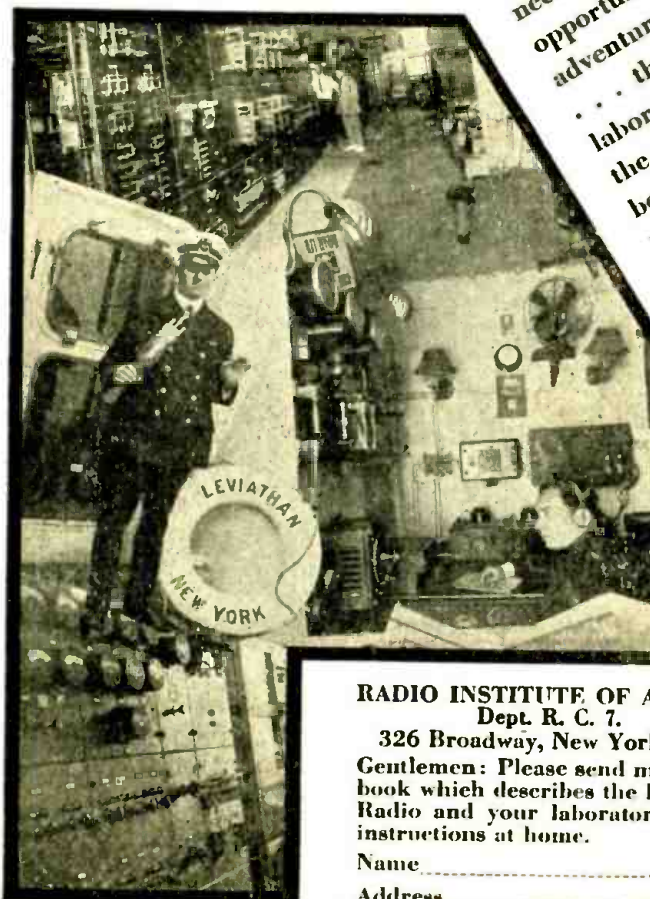

FREE!
This valuable book on Radio's great opportunities... written by one of America's well-known authorities.

RADIO INSTITUTE OF AMERICA
Dept. R. C. 7.
326 Broadway, New York, N. Y.

Gentlemen: Please send me your big FREE 50-page book which describes the brilliant opportunities in Radio and your laboratory-method of guaranteed instructions at home.

Name _____
Address _____

1929 "Harkness Screen Grid De Luxe"

By KENNETH HARKNESS *

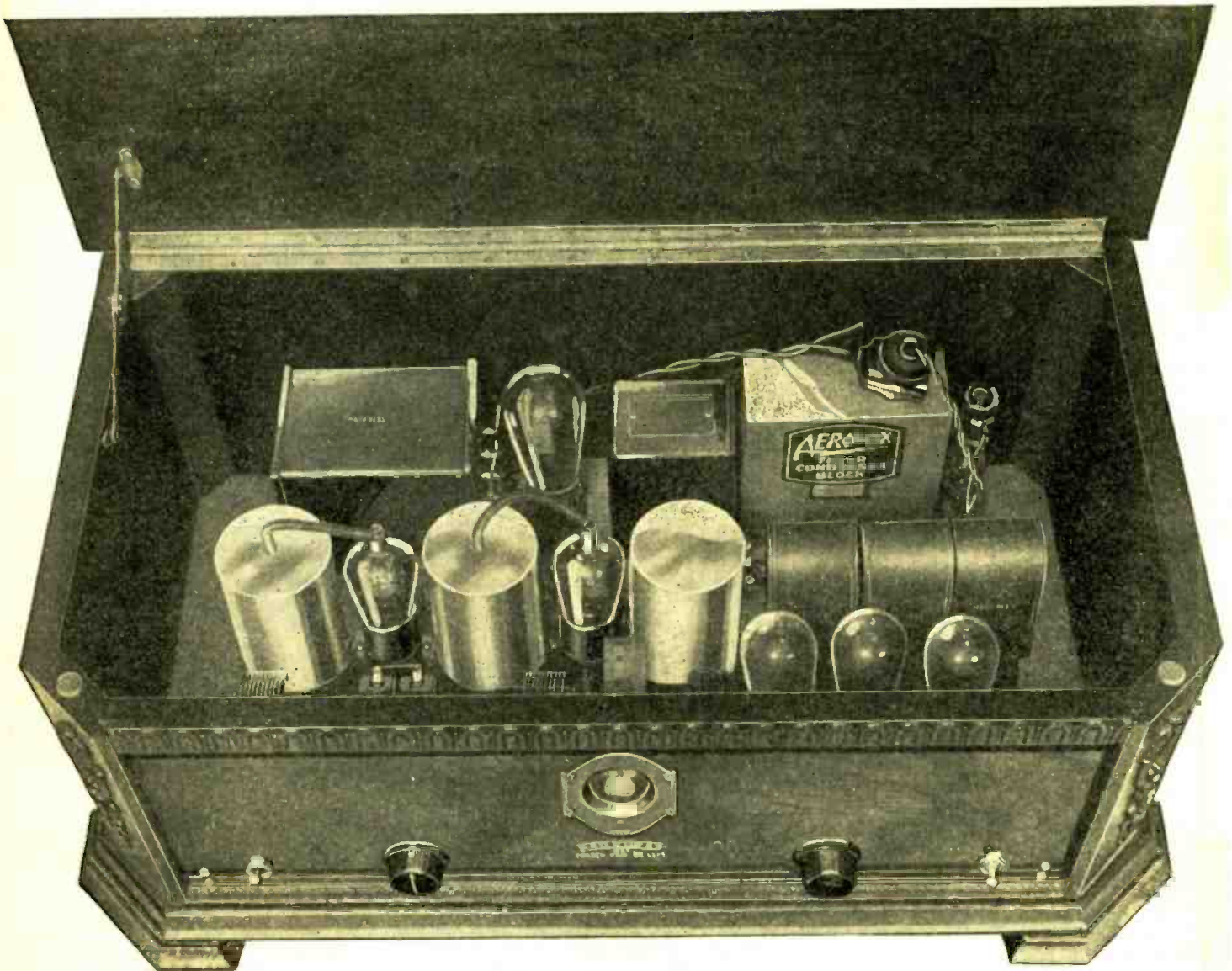

OVER five years ago, the Harkness single tube Reflex was developed for the custom set builder. Its reception was immediate and widespread.

Each succeeding year the custom set builder was offered a new model receiver incorporating the latest developments of the period. These ranged from the 3-tube "Counterflex" to the "Screen Grid 5" of last year, and included the 6-tube "Counterfonic" receiver in which the now well-known Hiler audio amplification system was introduced.

Up to a year or so ago it was generally considered that radio frequency amplification had reached its zenith; that it remained only to increase the number of radio frequency stages in order to increase the sensitivity of a receiver.

The advent of the screen grid tube swept into the discard all these ideas.

With an amplification of perhaps 10

THE custom set builder who wants to construct a single dial control receiver having as few controls as possible and incorporating the latest developments in circuit arrangement, will do well to build a screen grid design such as the one described by Mr. Harkness, the 1929 DeLux model of an earlier engineering job.

Selectivity, sensitivity, volume and quality are all combined in correct degree, in this radio receiver.

It is designed to fit standard cabinets. Even the A.C. model with its entire current supply can be accommodated in such a cabinet.

per stage, the older tubes were considered to be performing particularly well. The new tube, with its amplification ranging to 200, and better, depending upon the frequency, changed these ideas entirely.

It has taken some time to perfect the circuits which function best with the screen grid tube. The "Screen Grid 5" of last year was a big improvement over receivers of that time. However, laboratory experiments have shown the way to increased amplification, selectivity, sensitivity and volume, using the screen grid tube.

For example, it was at first considered desirable to have controllable oscillation in the radio frequency stages as an aid to sensitivity. Later experiments proved that *elimination* of this circuit oscillation would result in increased sensitivity. By proper placement of parts, judicious screening, correct circuit connections, coil and condenser constants

*Kenneth Harkness, Inc.

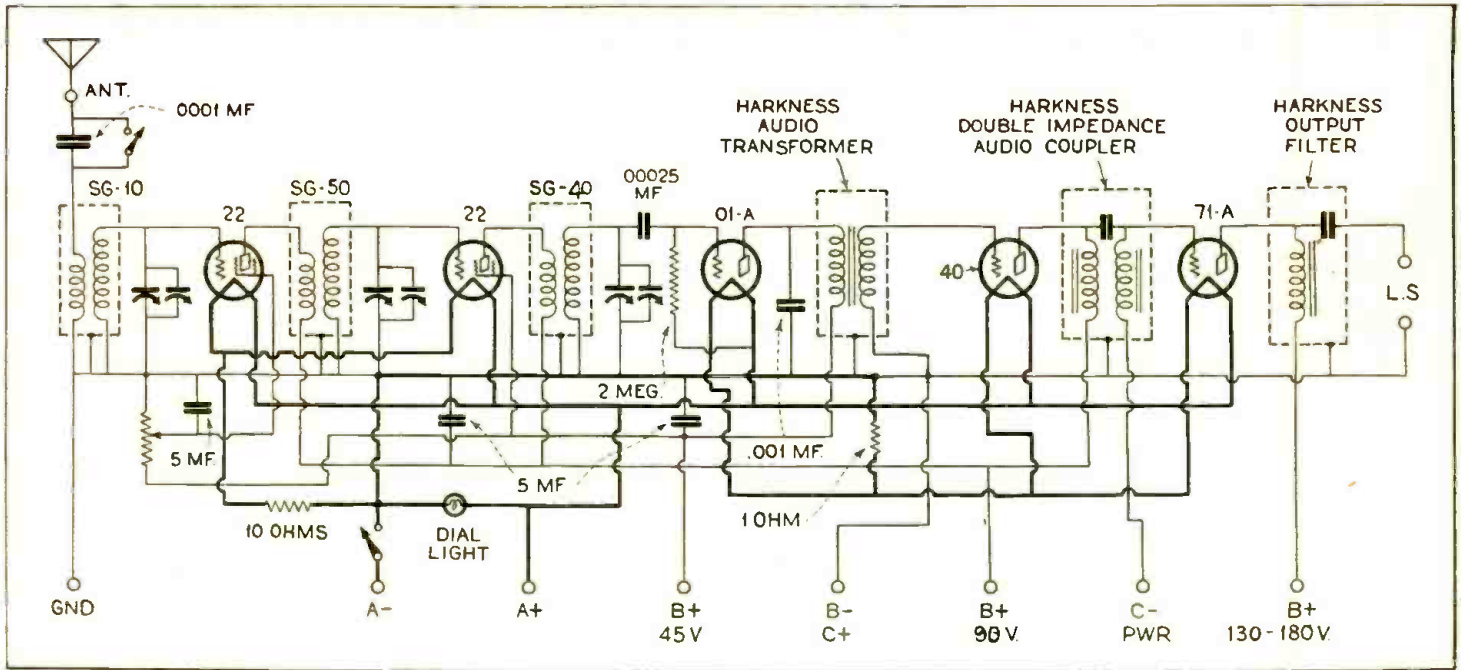

Schematic circuit of the battery model. Harkness Screen Grid 1929 DeLuxe model radio receiver. The text information is complete even to radio frequency coil data, although most experimenters will prefer to obtain manufactured coils and use the construction time for other purposes. Corrected D.C. coil numbers are: SG-10, SG-60, SG-60, and by-pass condenser value: 0.5 mfd. (not "5" mfd).

and resistance values, this circuit oscillation was successfully eliminated.

Also, the coil constants of the 1928 receiver were improved upon, taking full advantage of the other circuit modifications. This has all resulted in increased sensitivity and selectivity in the 1929 receiver.

The older set, too, used a volume control which has since then come into quite general use. However, it was noted that at low volumes for local reception, detection took place in one or more of the radio frequency tubes. This caused considerable tone distortion. To correct this experiments were conducted with various forms of volume control. The result was incorporated in the new receiver.

The Harkness Laboratory is located in downtown New York and few receivers are capable of cutting through the locals to bring in distance. The new DeLuxe, however, tunes in WLW, Cincinnati, at four o'clock in the afternoon, and a long list of "outside" stations during the early evening hours. WABC, a loud local, resonates at 59 on the dial; at 58, WLS, Chicago, comes in and Toronto (CFCA) at 61.

The custom set constructor will welcome a receiver with this sensitivity and selectivity, which requires only one tuning dial.

This receiver can be built either for D.C. or for A.C. operation. The changes necessary to modify one to the other are included in this article.

Construction Details

To a considerable extent, the radio frequency transformers are responsible for the unusual sensitivity and selectivity of the "Screen Grid DeLuxe," so these will be described first.

After many experiments to determine the most efficient method of coupling the stages of a screen grid R.F. amplifier it

was decided that the transformer method is the best, provided the transformers are correctly designed.

Many different types of transformers were wound before the type finally decided upon was adopted.

By winding the primary with very fine wire a large inductance was obtained in a very small space. This primary is wound over the secondary at the low potential end of the secondary coil, both coils being wound in the same direction and thin insulation used to insulate one winding from the other. The capacity between primary and secondary is thus kept low but magnetic coupling of the correct degree is obtained. Experiments

proved this transformer to be highly efficient at all points on the tuning scale.

The oscillation controls previously described in a general way are more completely described below.

Experiments made with various models of the 1928 model DeLuxe indicated that the mechanical arrangement of the radio frequency components had most to do with circuit oscillation.

A triple-gang condenser was used and it was necessary to run relatively long grid leads to the stator plates. At the very high amplification level of the screen grid tube, considerable capacity coupling was experienced which caused circuit oscillation. In addition, the couplings be-

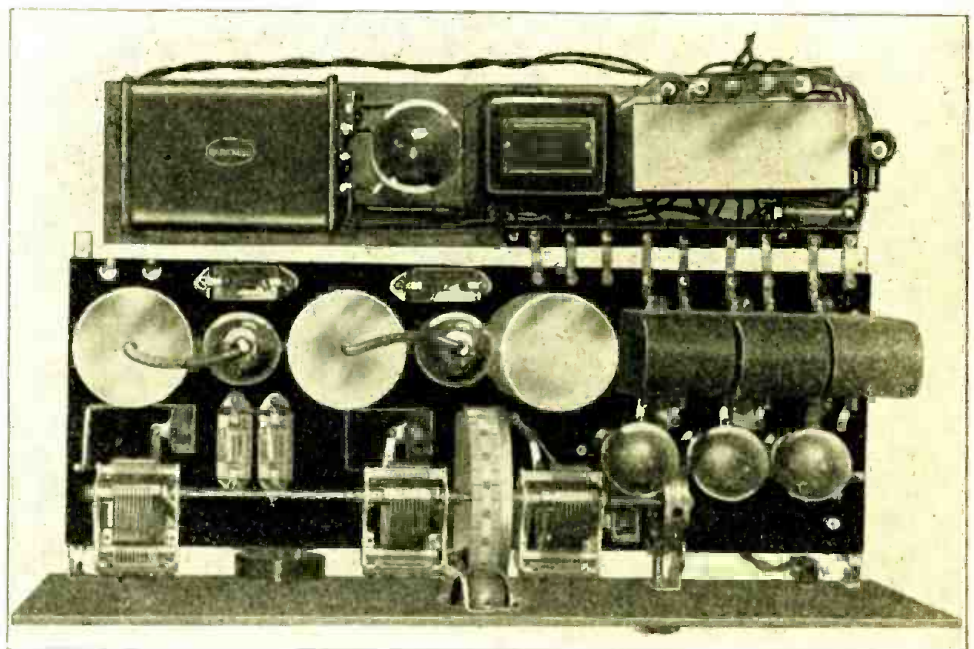

As the A.C. model appears when looking down into the cabinet. The parts layout is practically identical with the battery arrangement. Of course, the power supply unit shown in rear is not needed for battery operation, although the "B" eliminator feature of the pack can be applied.

tween the stator units of the variable condensers added their bit to the capacity coupling between circuits.

These faults were eliminated by using individual variable condensers and spacing them more widely; and locating them closer to the coils which they tuned. From a practical standpoint, these short grid leads and condenser placement eliminated capacity feedback.

Those who do not live in large cities and wish to "fish" for stations by the beat method may do so by increasing, from 45, to 67 volts the plate potential of the detector; this is also the screen grid voltage.

As the schematic circuit shows, complete volume control is obtained by varying the potential of the first tube screen grid, as against varying the screen grid voltage of every screen grid tube in the set. As the current load through the 100,000 ohm volume potentiometer is less this way, there is less chance for microphonic contact noises.

Unit Details

As variable condensers of .00035 mfd. capacity are used, the radio frequency transformer secondaries consist of 125 turns of No. 28 enameled wire on a one and one-half inch closely threaded bakelite tube. The number of primary turns varies and is indicated by the type num-

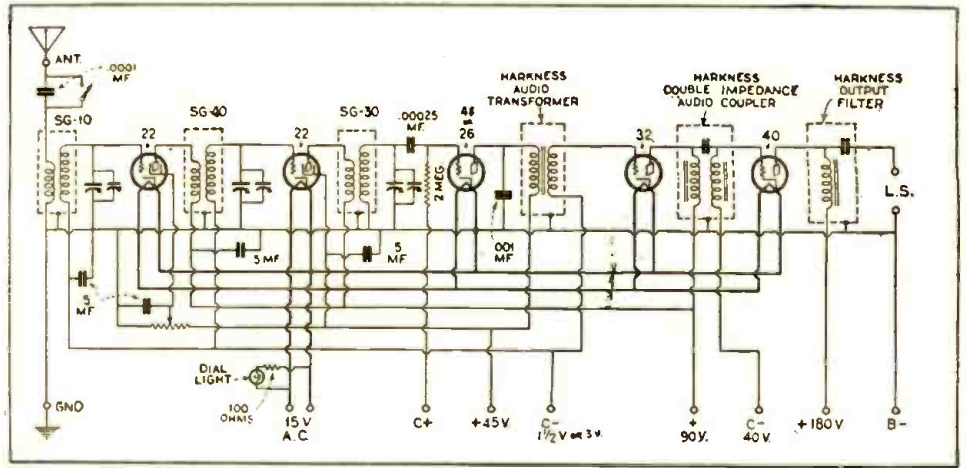

The schematic circuit of the A.C. model. The correct number of turns for the radio frequency coils is specified in the text. Corrected A.C. coil numbers are: SG-10, SG-40, SG-40.

ber (for example, "SG-10," the antenna coil, has ten primary turns.) No. 38, D.S.C. wire is used.

To balance the tuned circuits, as a final adjustment, midget condensers of 35 mmfd. are used in shunt to the tuned circuits. Their purpose is to balance the wiring and internal tube capacities, as well as the capacity variations of the other parts used. This results in maximum sensitivity and selectivity at all points of the tuning scale, and correct

dial readings. These equalizers are adjusted with an ordinary screw driver. (It is not necessary to use an insulated screw driver for this purpose as the movable leaves of the equalizers are at ground potential. This is a desirable attribute.) The adjustments are made on a distant, weak station; the equalizers must be adjusted very slowly and carefully.

A fixed condenser of .0001 mfd. capacity in series with the antenna serves to

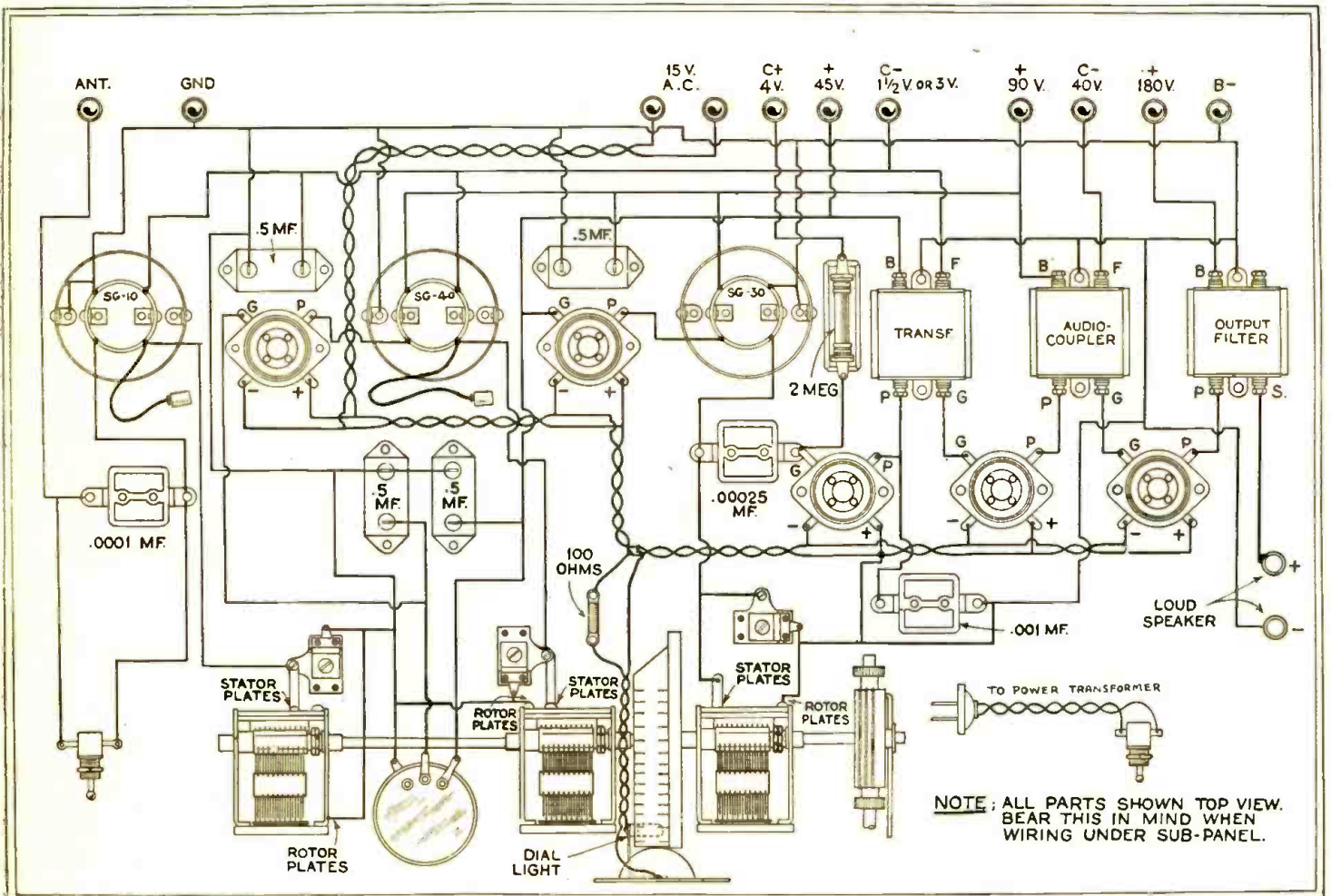

Pictured layout and circuit connections of the A.C. model (which is practically the same as the battery model) Harkness set. Exact coil sizes are given in the text. This particularly satisfactory R.F. arrangement may be followed by any form of audio amplification. The circuit balancing variable condensers connect directly to the tuning condensers.

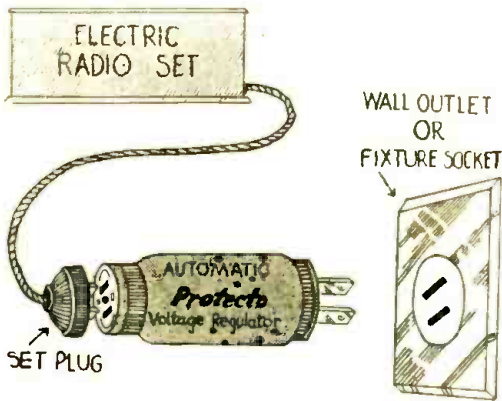

"Protecto" Air-Cooled Automatic Voltage Regulator. - - - Price, \$1.75

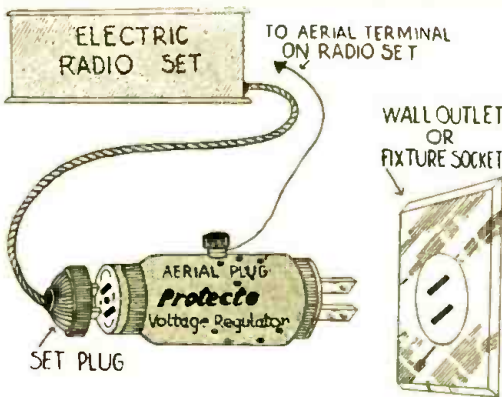

"Protecto" Combination Air-Cooled Voltage Regulator and Aerial Plug. Price, \$2.50

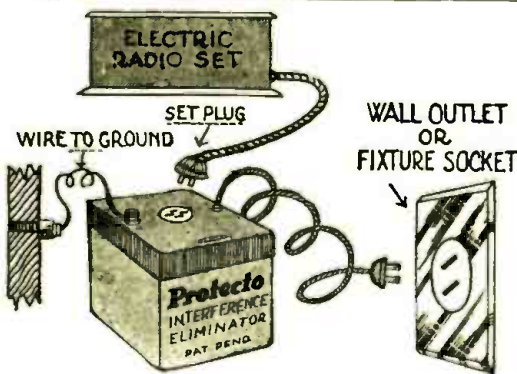

"Protecto" Senior Interference Eliminator. - - - Price, \$12.50

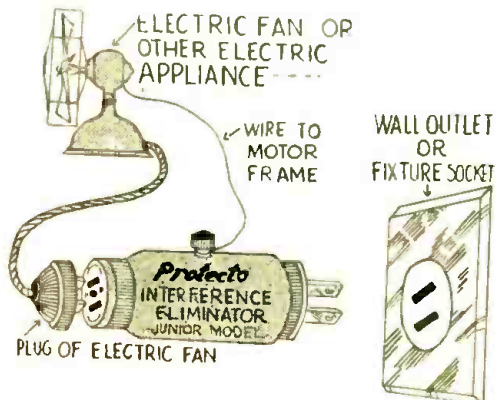

"Protecto" Junior Interference Eliminator. - - - Price, \$3.50

Radio Set Owners!

Why keep replacing burned out radio tubes? Why be bothered with interference spoiling your reception?

The New Air-Cooled Automatic Voltage Regulator is guaranteed to prevent your radio tubes from burning out by keeping the line voltage at the normal 110 volts. It holds back all excess current that damages tubes and set. Also acts as a fuse in case of short circuit in set, preventing damage to tubes and set wiring.

The New "Protecto" Air-Cooled Combination Aerial Plug and Voltage Regulator is made for those who desire to have a superior aerial connection and protect their tubes at the same time.

Many of the noises which are blamed on "static" are in reality disturbances from the electric light circuit.

The "Protecto" Interference Eliminator assures clear, static-free reception.

The "Protecto" Interference Eliminator is manufactured in two models. The Senior Model is connected directly to the set and the Junior Model is connected to the source of interference.

"Protecto" Products are sold by all Progressive Dealers. If your dealer cannot supply you, send your order directly to us.



Manufactured and Guaranteed by
THE PROTECTO MFG. CO.
 2211 Cortelyou Road Brooklyn, N. Y.

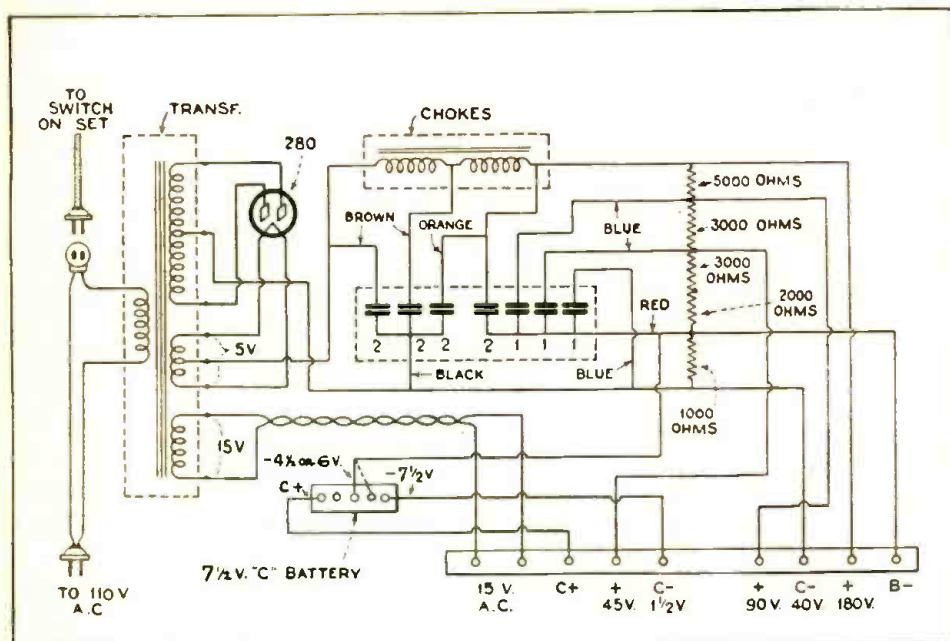

The humless current supply unit of the A.C. model. (A full wave rectifier is an aid in reducing hum.)

balance various antenna conditions. A short circuiting switch cuts this in or out of circuit. For short or indoor aerials the condenser is not needed. For long aerials it will be used to balance the dial readings and increase selectivity.

The Hiler System audio units are used (under license) for the second stage and a 3.5 to 1 ratio audio frequency transformer for the first. The coupling condenser value required for the double impedance unit is .02 mfd. for the particular impedances used. This is built into the unit, as is also the 1.0 mfd. fixed condenser in the output unit. The audio system finally developed has just the right characteristics for the tubes recommended ('01A's and a '71 type tube). Bass notes and highs as well are clearly amplified without the usual accentuation of either.

The list of parts for the D.C. kit follows:

Battery Model Parts

- 1—Front Panel, drilled and engraved, 7 x 21 inches
- 1—Sub-panel, drilled, 7 x 20 inches
- 1—Pr. Harkness Sub-panel Brackets
- 1—Harkness R.F. Coil, Type SG-10
- 2—Harkness R.F. Coils, Type SG-60
- 3—Harkness Aluminum shields
- 1—Harkness A.F. Transformer
- 1—Harkness Double Impedance Coupler
- 1—Harkness Output Filter Unit
- 3—U.S.L., .00035 mfd. Variable Condensers
- 3—Hammarlund Equalizers
- 1—Hammarlund Drum Dial
- 3—Aerovox, .5 mfd. Fixed Condensers
- 3—Aerovox Fixed Condensers, as indicated
- 1—Aerovox Grid Leak Mounting
- 1—Aerovox Grid Leak, 2 megs.
- 2—Saturn Switches
- 1—Centralab Potentiometer, 100,000 ohms

- 5—Eby UX Tube Sockets
- 2—Eby Tip-jacks
- 2—Carter Shield Grid Tube Clips
- 1—Carter, 10-ohm Resistance
- 1—Carter, 1-ohm Resistance
- 1—Condenser Shaft, one-quarter inch
- 9—Eby Binding Posts

And the usual collection of hardware.

The A. C. Model

The tubes used in the A.C. model are of the 20-second, 15-volt type made by Arcturus.

As the cabinet is standard for either set, there is no need to obtain a special cabinet to house the power unit necessary to operate the A.C. receiver. The Corbett cabinet is 12 inches deep and this is quite sufficient.

The A.C. kit is constructed as two separate units, the receiver and the power supply. Then, their connection strips are strapped together to complete the set.

The right hand switch of the A.C.

model is used to control the line supply to the power unit and hence, to the receiver.

When A.C. tubes are used, it is recommended that the primary turns of the second and third radio frequency transformers be reduced to 40, as the characteristics of these tubes are not the same as the battery type. Instead of 15 volt tubes, lower filament voltage tubes such as the UY-224 can be used. A few circuit modifications, outlined in a Direction Sheet accompanying each tube, complete the change.

Except for a few changes, the parts for the A.C. model are the same as for the D.C. model. There is one more Aerovox fixed condenser, 0.5 mfd.; but only two binding posts. Instead of a Carter 10-ohm resistance, a Carter 100-ohm resistance is used. Instead of type SG-60 radio frequency transformers, type SG-40 are used. The Carter one-ohm resistance is not needed.

The layout and wiring of the power compact are clearly shown in the illustrations. The unit delivers full power to the receiver and therefore motor-boating does not result. If the filament transformer is left out of the construction, a satisfactory "B" supply remains for the direct ("A") current model set.

In fact, any receiver can incorporate this unit in its cabinet if there is a clearance with the dimensions of the unit, the size of which is, 19 inches long, by 7 inches high, by 4 inches deep.

The parts needed to build the pack are:

"A", "B", "C" Power Unit Parts

- 1—Harkness Power Transformer
- 1—Silver-Marshall UniChoke, No. 331
- 1—Aerovox B-C-280 Condenser Block
- 1—Aerovox 996, '71 Resistance
- 1—Aerovox 992, 1,000-ohm Resistance
- 1—Eby UX-type Socket
- 1—Terminal Strip, drilled
- 1—Baseboard
- 1—"C" Battery (seven and one-half volts)

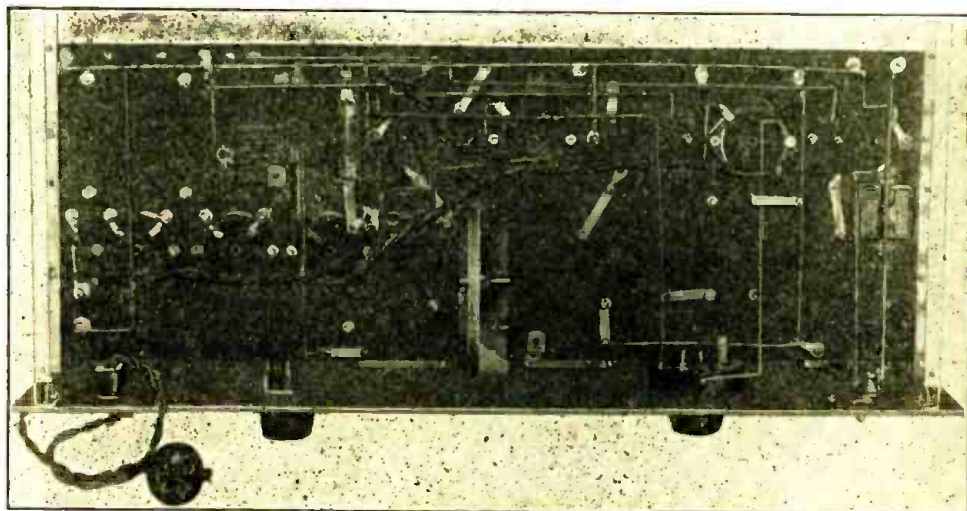

Under sub-panel. A.C. model. The twisted leads are filament supply. Sub-panel must be cut out to make room for the control dial.

To the Readers of RADIO CRAFT -Greetings-

The CLAROSTAT family is delighted to join you in the pages of this new radio periodical which, edited and published by men of proven ability, is certain to contribute in no small measure to the advancement of the radio art. Month after month we shall meet in these pages for the purpose of treating with the latest radio circuits and refinements and components. And it is our hope to contribute our share to this radio forum, in the form of AIDS TO BETTER RADIO. Keep in touch with us by following our advertising message each month!

Meanwhile, let us introduce the present members of our family, leaving for future issues the announcements of new arrivals:

GRID LEAK CLAROSTAT

Micrometrically adjustable resistor of high resistance value, for precise grid leak functions and plate resistors. Also indispensable in short-wave work. 0-10 megohm range.



VOLUME CONTROL CLAROSTAT

Micrometrically adjustable resistor for controlling loud-speaker volume, plate voltage, regeneration and other functions in usual receiving circuit. 0-500,000 ohm range.



STANDARD CLAROSTAT

Universal variable resistor for all receiving circuit applications and also for voltage control in radio power units. 0-5,000,000 ohm range.

HUM-DINGER

Unique hum balancer for A-C tube circuits. Screwdriver adjustment. Compact. Durable. One-hole mounting.

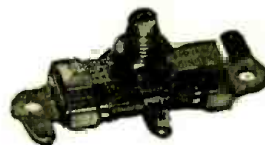

SUPER-POWER CLAROSTAT

The BRUTE POWER variable resistor for heaviest duty in radio power amplifiers and transmitters. Three available ranges: 0-10, 25-500, and 200-100,000 ohms. Dissipates 250 watts.



POWER CLAROSTAT

Intended for heavy duty applications, such as line-voltage control, series-filament control, reducing high voltages to those required for receiving circuits, for transmitters and so on. Three available ranges: 0-10, 25-500, and 200-100,000 ohms. Dissipates 80 watts.



DUPLEX CLAROSTAT

Two variable resistors in one, with screwdriver adjustment. Ideal for semi-fixed resistance requirements. Two-hole mounting or with special bracket.



WIRE-WOUND RESISTORS

Improved and refined fixed units, with threaded fibre support to prevent slipping and short-circuited turns. Accurate resistance value stamped on one end.



TABLE TYPE CLAROSTAT

Handy volume control in accessory form. Applied without tools or alterations. Ideal phonograph pick-up. Provided with connecting cords and block for series or shunt applications.



CLAROSTAT ANTENNA PLUG

Novel form of socket antenna plug, with special coupling condenser. Better than usual antenna as a signal pick-up. Provided with long connecting cord. Absolutely safe. Draws no current.

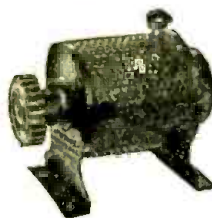

SPEED CONTROL CLAROSTAT

Heavy-duty variable resistor in handy metal casing with mounting feet. Protected screw terminals. Short-circuiting button. Intended primarily for Television synchronization. Will control variable speed motor up to 1/4 horsepower.

WRITE for the balance of our story. It is obviously impossible to tell you all about CLAROSTATS and their uses in this limited space. Better still, send 25 cents in stamps or coin for "The Gateway to Better Radio"—88 illustrations and 20,000 words of practical radio information.

CLAROSTAT MANUFACTURING COMPANY, Inc.
Specialists in Radio Aids

295-7 North Sixth Street

Brooklyn, N. Y.

A Portable Screen Grid Four

Unique and Efficient Circuit Successfully Applied to Portable Model

By H. G. CISIN, M.E.

This portable radio set weighs 21 pounds. It is possible to receive Dance Music, Special Talks ("Main Street Sketches," and other highly enjoyable offerings of a similar nature), music other than that intended for dancing, reports of Sporting Events, and all the other things which are the combined product of the ingenuity of program directors and the expressed desires of radio listeners, under very unusual conditions and at out-of-the-way places.



Photograph of portable receiver designed to include the new screen grid tube. As the current drain of this tube is slight, it lends itself well to use in receivers such as this one.

FIRST of all, the prospective set builder will want to know something about the capabilities of the Portable Screen Grid Four. This set brings in local stations on the loop with good volume. Even though high-ratio audio transformers are used, the tone quality is excellent. All local stations can be separated readily, even in congested broadcast districts; the use of the loop adds to the selectivity of the receiver. The Portable Screen Grid Four was given a preliminary test in Brooklyn, N. Y., and it convincingly demonstrated its distance-getting ability. After the locals had signed off, this receiver brought in WLW, Cincinnati, Ohio; WJSV, Mount Vernon Hills, Va., and also several Chicago stations. These were all brought in on a magnetic type loud speaker. While the volume was only fair, still the reception was clear and

readily understandable. It is possible to increase the distance range of this set still further, by connecting an aerial and ground to a single turn loop, which is closely coupled to the loop ordinarily used for reception.

Construction Details

In the portable model, the loop takes the place of an antenna coupler. There is a stage of radio frequency using a screen grid tube, a regenerative detector and two transformer coupled audio stages.

Only one shield is used in this set, besides a cover for the screen grid tube.

Single dial tuning is attained by "ganging" together the two variable condensers. A small equalizing condenser is shunted across the loop. A three-circuit tuner couples the R.F. stage to the detector.

In order to conserve space, the small type audio transformers are specified. A $3\frac{1}{2}$ to 1 ratio transformer is used in both audio stages.

The portable requires one screen grid tube, two '99 type tubes and one '20 power tube. Amperites regulate the filament current. If it is desired at any time to operate this little receiver as a home set instead of a portable, '01-A tubes may be substituted for the '99's and a '71-A for the '20. In this case, it is merely necessary to interchange amperites, using the ones specified for the type of tube substituted. In order that the correct control grid bias may be obtained without the use of an extra "C" battery, a 5-15-ohm tapped resistor is used. Various grid leak values should be tried for best results.

The constructor will find the Portable Screen Grid Four easy to assemble and wire. The sub-panel method of construction is followed, with most of the wiring performed beneath the sub-panel. The sub-panel should be cut to the correct size. It should fit the inside of the case snugly. The shield bottom is then mounted at the front of the sub-panel, as shown in the top view illustration of the receiver.

The variable condensers (7, 10) are mounted next. These are "ganged" together by means of a single brass shaft, $8\frac{1}{2}$ " long. The condenser shaft is located exactly on the center line of the sub-panel. The front edge of the condenser (10) is mounted $\frac{1}{2}$ " from the front of the sub-panel. There is a space of $1\frac{1}{2}$ " between the two condensers. Coil (16) is now mounted on the shield bottom. It should be placed far enough

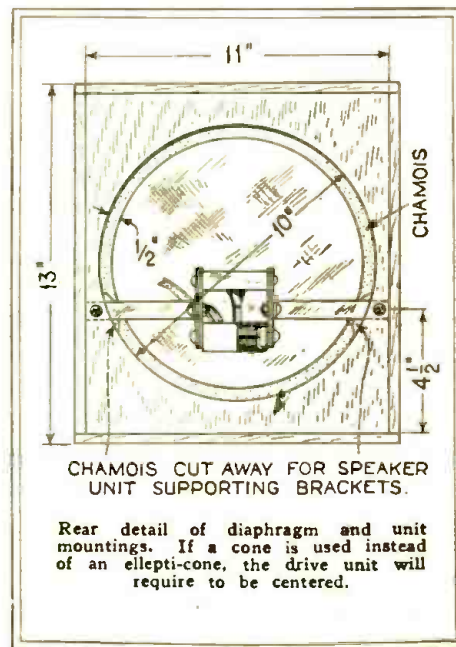

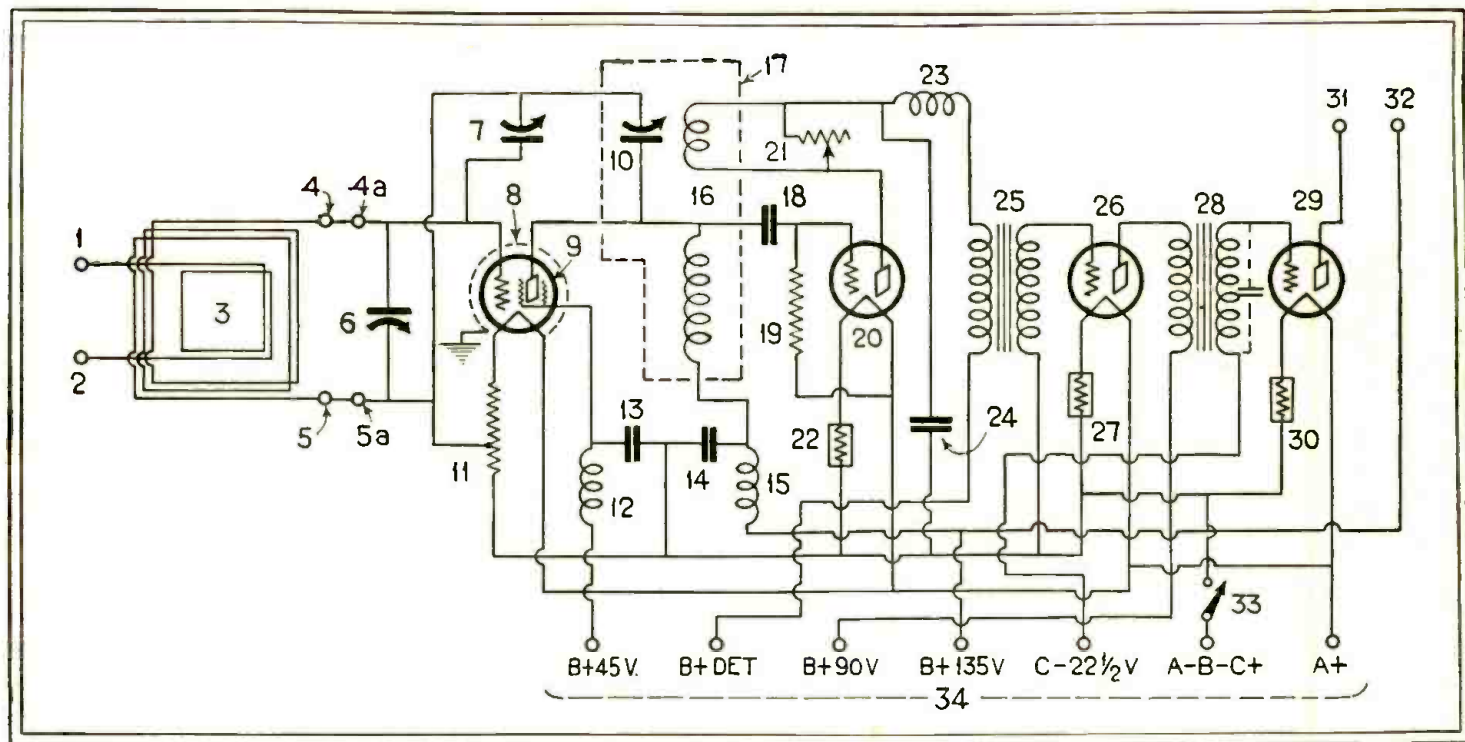

Schematic circuit of the Portable Screen Grid Four. Care must be used in shielding the detector circuit coils; a metal case too close to these coils will cause a considerable loss in volume and also broad tuning.

from the front edge to leave sufficient room for the resistance (21), when the latter is mounted on the panel. Condensers (14) and (24) are mounted vertically on the coil, condenser (14) being soldered to terminal 5, of the coil, and condenser (24) being soldered to terminal 3.

The positions of the four sockets (9, 20, 26, 29) are marked and the necessary mounting holes are drilled and then sockets (20), (26) and (29) are mounted. In order to fit the adaptor ring (8) about socket (9), it is necessary to file off the oval shaped flange on this socket, leaving only the central circular portion. The adaptor ring fits closely over this and when fastened in place, also holds the socket firmly.

The portion of the shield (17) comprising the four sides, is now put into place. The two R.F. chokes (12) and (15) are mounted in back of the shield on each side of the sub-panel center line and the R.F. choke (23) is fastened to the left side of the shield, with its center line $1\frac{3}{4}$ " from the top of the shield. The three amperite mountings (22), (27) and (30) are next fastened in position at the rear of the sub-panel, as indicated in the illustration. The tapped resistor (11) should be mounted beneath the sub-panel. It should be soldered to the "A" minus prong of socket (9) with the tap nearest the free end. Condenser (13) is also fastened beneath the sub-panel, being soldered to the same "A" minus prong. If a cable terminal is used, this should be mounted at the rear center of the sub-panel and the two binding posts (4a) and (5a) may be mounted directly on this terminal.

The grid leak mounting (19) is fastened near the detector tube (20). The

grid condenser (18) is mounted beneath the sub-panel, being soldered directly to the grid prong of the detector socket (20). The two audio transformers (25) and (28) are mounted as shown. Transformer (25) should be placed far enough from the front to clear the midget condenser to be mounted on the panel. Holes are drilled at the rear of the sub-panel for the tip jacks (31, 32) and these are mounted.

Preparing the Panel

The panel is now cut to its specified size, 6"x11". The exact location of the condenser shaft is "spotted" on the panel and a hole is drilled for this. Holes are also drilled in the sides of the shield, for the condenser shaft.

A hole is drilled in the panel for

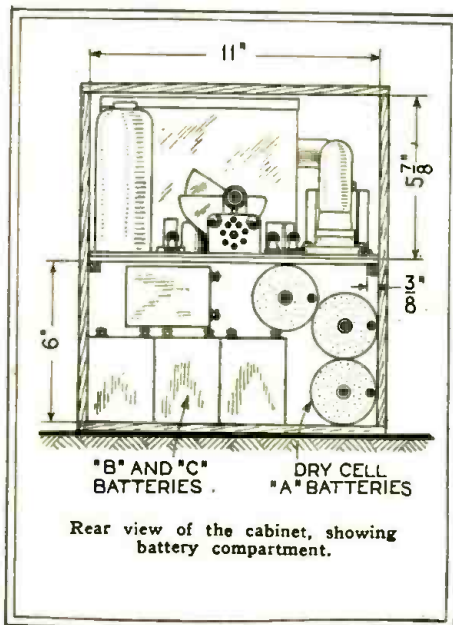

mounting the midget condenser (6). This is located on the horizontal center line, 2" from the left edge. A hole is also drilled symmetrically, 2" from the right edge of the panel, for the regeneration control (21). The mounting hole for the switch (33) is also drilled at this time. This is located on the vertical center line, 1" from the top of the panel. A hole is drilled at each lower corner of the panel, for fastening the panel to the brackets. These small right-angle brackets are bolted to the panel and sub-panel, as shown in the top view drawing. The brackets are first fastened to the panel, then holes are drilled in the sub-panel for them, and the panel is thus securely fastened to the sub-panel.

The midget condenser is mounted on the panel. Holes are drilled in the front side of the shield for the switch and the regeneration control and these also are mounted. In order to prevent the chance of a short circuit, a piece of varnished cambric or similar insulating substance should be placed between the shield and the resistance (21).

Wiring the Portable

First, wire the "A" minus circuit from the cable or cable terminal to the switch (33). Then, wire from the switch to the amperites and from the amperites to the sockets. The "A" minus lead should also be wired to the free end of the resistor (11).

The "A" plus leads should now be wired from the sockets to the cable. The various grid circuits are wired in next. The grid lead from the cap of the screen grid tube (9), is shielded and goes to the stator of condenser (7). This lead should be made as short and direct as possible. The tube shield and also the grid lead shield should be grounded.

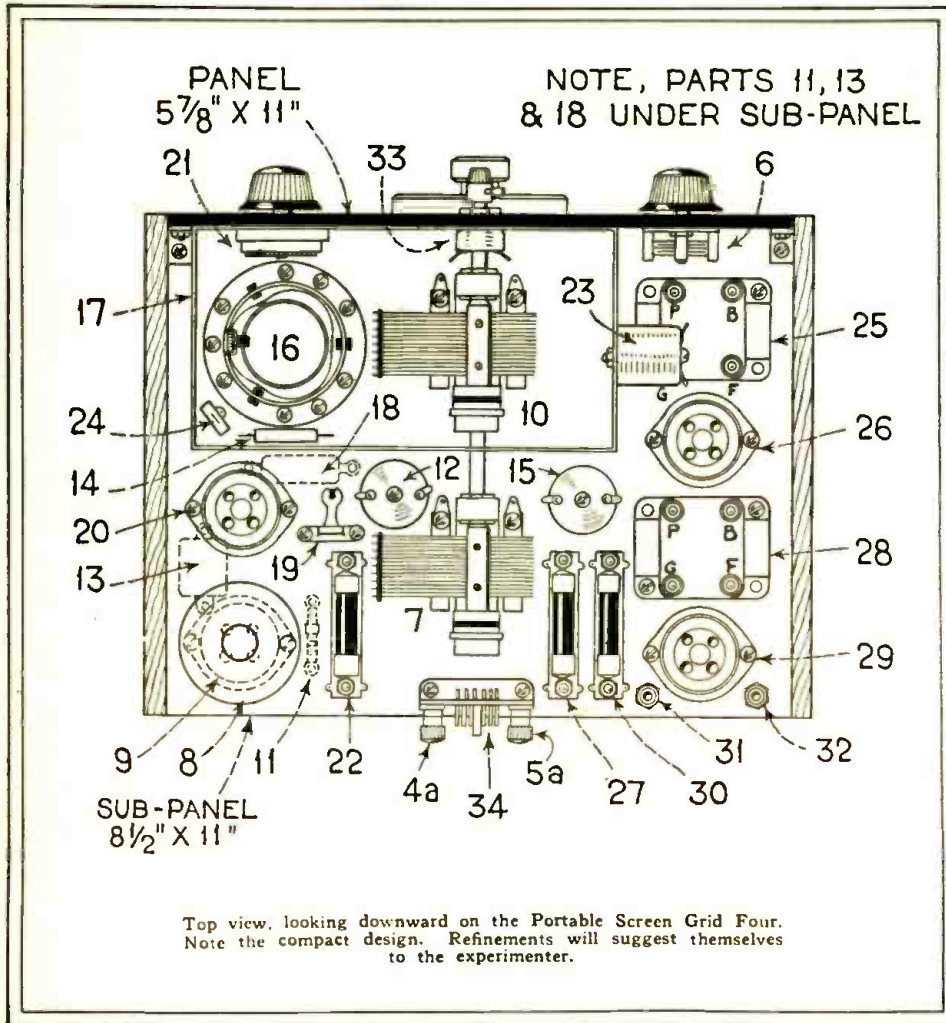

Due to the fact that the midget condenser (6) is located on the panel, the lead connecting the stator to the stator of condenser (7) and to the control grid of the screen grid tube, is necessarily rather long. Hence, it is desirable to have this lead carefully shielded also, grounding the shield. (Unfortunately, not all "S-G" tubes are good; therefore, check this up when purchasing the tube.)

The plate circuits are wired next, then the "C" minus return from the secondary of transformer (28) and finally all the "B" plus returns are wired in. In wiring the coil (16), if a three-circuit tuner is used, do not utilize terminals 1 and 2. Terminals 3 and 4 go to the rotatable primary, which is used in this case as a tickler. Terminal 3 is wired to the R.F. choke (23). Terminal 4 goes to the plate of the detector tube (20). Terminal 5 goes to R.F. choke (15), while terminal 6 goes to the stator of variable condenser (10) and to the grid condenser (18).

All parts of the portable, including the set itself, the necessary dry batteries, the loop and the cone speaker are housed in a wooden box 11 1/4" wide, by 13" high, by 13 1/2" deep. The receiver itself occupies the upper part of the box space, while there is plenty of room in the lower portion for the necessary "A", "B" and "C" batteries. The set requires three 1 1/2 volt dry cells in series for the filament supply. The screen grid tube draws .132 amp., the 120 tube draws .125

amp., while each 199 tube draws only .06 amp. The total "A" current required is .377 amp. Six 22 1/2 volt small size dry units are used as the "B" battery. An additional 22 1/2 volt unit serves as the "C". As these batteries are small, the "life" is not very great, so do not use a low resistance meter to check voltages.

The constructional details of the carrying case or cabinet are given in the accompanying diagrams. The sizes of the various pieces of wood required will be found in the list of parts. The loop aerial is wound within the front cover, the loop being of the box type. It is necessary to determine the exact number of turns by experiment. About 60 feet of No. 18 annunciator wire will be required. A four turn primary is wound alongside the loop, to permit the use of aerial and ground when desired. A strip of bakelite or hard rubber is fastened within the cover, being used to mount the four binding posts. The terminals of the loop are soldered to the two inside posts, while the ends of the primary are soldered to the two outer posts.

The front cover is mounted on loose-joint hinges and when in use rotates upon a swivel inserted in the top of the case. This swivel consists of a 1/4" diameter brass rod, 1 1/8" long, with a washer soldered at its center. This rod rests half-way in a socket in the top of the case, made out of a bushing taken from

an open-circuit jack. A similar bushing provides the socket in the cover containing the loop. The loop binding posts (4, 5) are connected to the binding posts on the receiver (4a, 5a) by means of two flexible leads.

When the receiver is mounted in the case, it rests on two wood strips, 8" long by 3/8" wide. These are fastened within the case, on each side, as shown. The batteries fit snugly within the compartment below the receiver.

The Cone Construction

The loud speaker is constructed within the rear cover. The cone may be made of Alhambra paper or burlax. To make the cone, draw a large circle of the desired diameter on the paper and cut this out carefully. Then cut out a "V"-shaped segment. The width of the segment taken out, determines the depth of the cone, so care should be taken not to cut away too much. The cone, as made originally, should be a true cone, with its apex at the center. After it has been glued, it should be passed through the 10" hole in the back of the rear cover. Before doing this, draw a horizontal line 4 1/2" from the bottom, showing the level of the speaker unit drive pin. The vertical center line should also be drawn. The apex of the cone should now be lowered until it coincides with the intersection of these two lines. Next make a pencil mark around the edge of the cone, using the 10" diameter hole as a guide. The cone should then be cut about 1/4" smaller than the marking, in order to leave space for the chamois. Four or five pieces of chamois, about 1 1/4" in width, should now be cut, to go around the outside circumference of the cone. Glue each piece to the cone with only 1/4" overlap, so as to form a continuous ring. Be sure to leave enough chamois on the outside edge to permit gluing to the wood frame. Mount the chamois on the frame with four thumb tacks. Then glue one-quarter of the circumference at a time, holding each portion with three or four thumb tacks until the glue sets. Work alternately on opposite sides, so that the tension will be evenly distributed, over the entire circumference of the cone. Make certain that the distance between the outer edge of the cone and the edge of the frame is even all the way around (about 3/8" or 1/2"). Remove the thumb-tacks as soon as the glue dries.

The speaker unit is mounted on two brass rods, having their ends fastened inside the cover. It is necessary to cut openings in the cone and chamois with a razor blade, for the brackets. The unit, when mounted, should be flush with the rear face of the cover. The cover containing the speaker should be mounted on loose-joint hinges, so that the speaker may be moved away from the set, in case microphonic noises are set up. The unit may be protected with a wire screen fastened across the speaker opening and an ornamental silk screen may be placed beneath the wire.

If the Screen Grid Portable is to be used as an automobile permanent re-

ceiver, the "A" supply may be obtained for storage battery tubes from the car's storage battery. To increase the volume the car chassis may be used as a ground or counterpoise and an aerial may be used on the top or just below it. Binding posts are provided for these two connections, although the receiver operates exceedingly well on the loop alone.

Complete List of Parts Required for the Portable Screen Grid Four

- 1—Aero Universal 3-Circuit Tuner, type U-55, with fixed tickler unused and with rotatable primary used as tickler; or Aero Universal Coil type U-7 (16)
- 2—.0005 Mfg. Hammarlund "Mid-Line" Variable Condensers (7, 10)
- 4—Eby Sockets, UX type (9, 20, 26, 29)
- 1—Electrad "Royalty" Resistance, type "F", 0—2000 ohms (21)
- 1—2 Meg. Durham Metallized Resistor Grid Leak with Durham Vertical Single Mounting (19)
- 1—.00025 Mfg. Polymet Bakelite Fixed Mica Grid Condenser (18)
- 2—Thordarson Transformers, 3½ to 1 ratio, type R-150 (25, 28); or a 6 to 1 ratio, type R-151 may be used at (28) for greater distance
- 2—Amperites, No. 4V-199, with Mountings (22, 27)
- 1—Amperite, No. 120, with Mountings (30)
- 1—Silver-Marshall Shield, type 631-A (17)
- 3—Silver-Marshall R.F. Chokes, type 276 (12, 15, 23)
- 1—Silver-Marshall Midget Condenser, type 340 (6)
- 2—.01 Mfd. Polymet Bakelite fixed Mica Condensers (13, 14)
- 1—.0005 Mfd. Polymet Bakelite fixed Mica Condenser (24)
- 1—Carter JU-5-15 Tapped Resistor (11)
- 1—Carter Tube Shield, No. 322; Connector Cap No. 342; with Shielded Wire, No. 352; Adaptor Ring No. 332 (8)
- 1—Carter "Imp" Battery Switch (33)
- 2—Carter Tip Jacks (31, 32)
- 2—Carter Open-Circuit Short Jacks for Loop Sockets
- 6—Eby Engraved Binding Posts (1, 2, 4, 5, 4a, 5a)
- 1—Roll Corwico Braidite, Stranded Core Hook-up Wire
- 1—Spool No. 22 Double Cotton Covered Corwico Magnet Wire for Loop (3)
- 1—7-Conductor Cable with Mounting Plate (34)
- 1—Can Kester Radio Solder (Rosin Core)
- 1—Composition Panel, 6" x 11" x 3/16"
- 1—Sub-Panel, 8 3/4" x 10 3/4" x 3/16"
- 1—Gold Seal Screen Grid Tube, type GSX222 (9)
- 2—Gold Seal Tubes, type GSX199 (20, 26)
- 1—Gold Seal Power Tube, type GSX120 (29)
- 1—Vernier Dial
- 1—Enesco Loud Speaker Unit
- 1—Sheet of Burtex or Alhambra Paper, 12" x 12" for Loud Speaker Cone
- 3—1½ Volt Dry Cells ("A" Battery)
- 7—22½ Volt "B" Batteries (Compact,

- portable type); or 3—45 Volt Batteries of Compact type with one 22½ Volt Battery
- 4—Brass Loose-Joint Hinges
- 2—Brass Clasps
- 1—Leather Strap for Handle
- Wood for Carrying Case—White Wood

trouble which may not perhaps be evident at first. Soldering paste often becomes absorbed by the insulation of jacks, and causes current leakage. In the plate circuit of the audio amplifier this would not cause objectionable operation; however, in the radio frequency in-

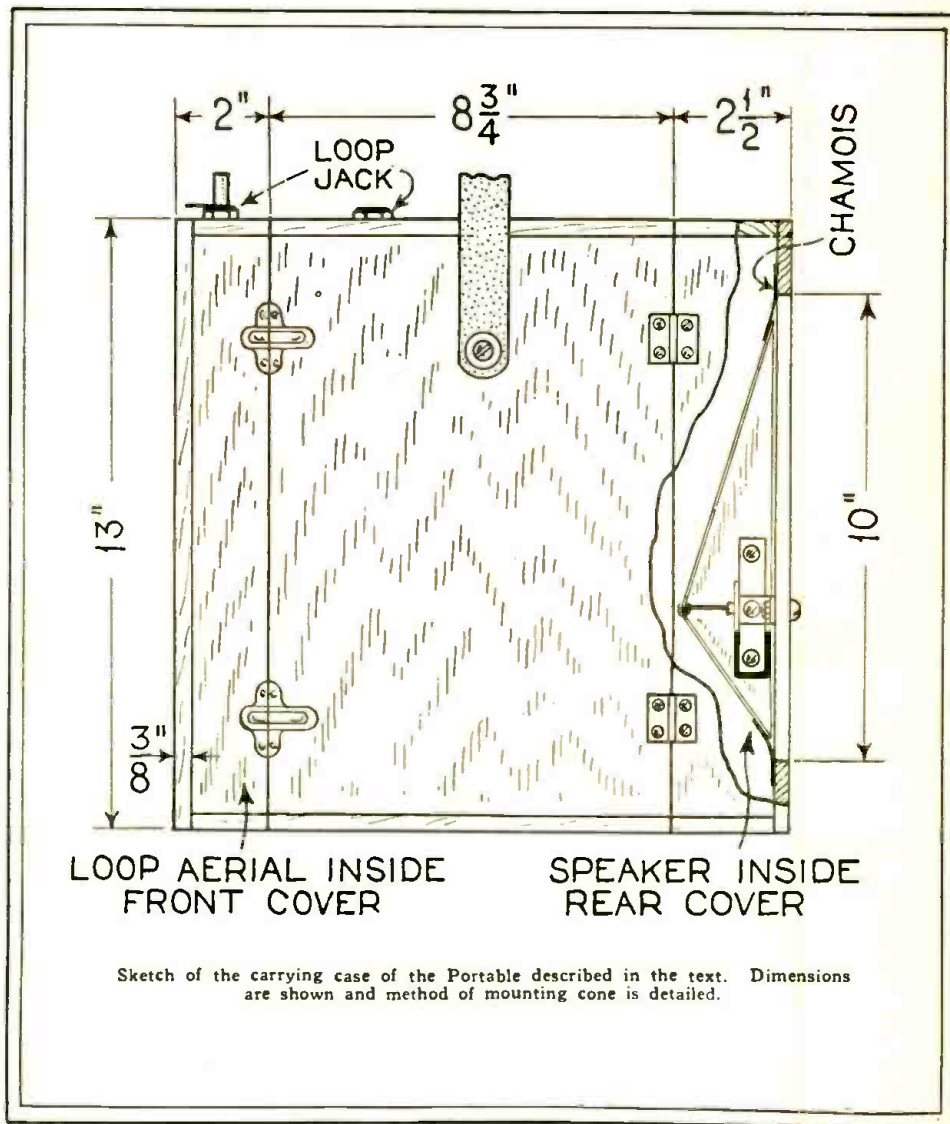

- 2 pieces, 11 3/4" x 8 3/4" x 3/8" (top and bottom)
 - 2 pieces, 12 1/4" x 8 3/4" x 3/8" (sides)
 - 1 piece, 6" x 11" x 3/8" (front cover of battery compartment)
 - Front Cover, containing Loop
 - 1 piece, 11 3/4" x 13" x 3/8" (front)
 - 2 pieces, 11 3/4" x 1 5/8" x 3/8" (top and bottom)
 - 2 pieces, 12 1/4" x 1 5/8" x 3/8" (sides)
 - Back Cover, containing Speaker
 - 1 piece, 11 3/4" x 13" x 3/8", with 10" dia. hole for Cone of Speaker
 - 2 pieces, 11 3/4" x 2 1/8" x 3/8" (top, bottom)
 - 2 pieces, 12 1/4" x 2 1/8" x 3/8" (sides)
- It may be well to point out a few of the structural difficulties occasionally encountered when constructing receivers of this general type.
- The loop jack is often a cause for poor circuit operation. Perhaps the insulation and design are good, but a poor job of soldering can cause a large amount of

put, or loop circuit of a receiver this leakage may be quite sufficient to reduce the efficiency of the receiver fully 50%.

In portable use, radio parts are subjected to vibration foreign to them in receivers permanently placed. For this reason, it is a good plan to use lock washers wherever a binding connection has been made. The crackles and general "kicking up" often caused by poor connections, are prevented by a little extra labor.

Still another trouble in portable sets is short circuit of the battery supply. Usually, it is the large "No. 6" dry cells which are the offenders, as the cardboard cases sometimes crack, permitting the zinc of one battery to short to the zinc of another battery.

Phone cords are a source of trouble as the "tinsel cord" (as the conductor is called) may break, or the cotton insulation may absorb moisture. Metal filings in the unit air gap will cause trouble.

The A.C. Screen Grid "Seven Seas" Console

A seven-tube radio set which includes three stages of R. F. amplification and push pull '10's for power audio amplification

By CHARLES R. LEUTZ *



The "Seven Seas" Console.

EXPERIMENTERS, set builders, and set users will be interested in the schematic circuit and instrument arrangement of a particularly efficient receiver incorporating A.C. screen grid tubes, which has just been announced.

It is called the "Seven Seas" Console,

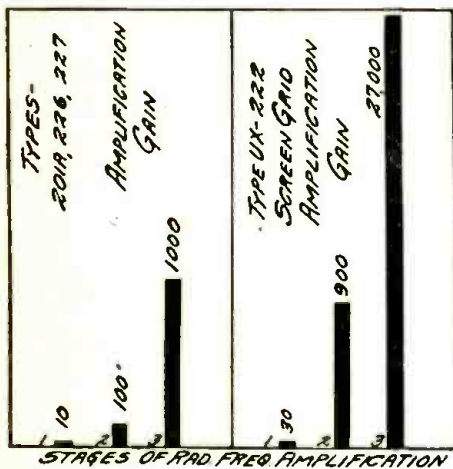

"Amplification Gain." The above graph illustrates the great difference in amplification obtained with three tuned stages using '01A tubes as compared with three tuned stages with screened grid tubes, in an efficient assembly scientifically shielded. (This desirable feature in a console is exclusive in the "Seven Seas" model at this writing.) To proportionately indicate the gain of "27,000," the line would be twice the length of this page!

*President, C. R. Leutz, Inc.

because of the unusual sensitivity of the completed unit. However, in addition to the unquestioned feature of extreme sensitivity are found the desirable qualities of excellent tone quality and ample volume. Selectivity is adequate for present day reception conditions.

Reasons for the Efficiency

The first requisite of the design called for sensitivity and selectivity without distortion due to circuit design or construction. The use of screen grid tubes answered the question of sensitivity, but it was difficult to obtain the selectivity necessary at the present time.

The first step was to completely shield the radio frequency tubes and their associated equipment. It will be noticed that the coils are individually shielded, the screen grid tubes are in individual shielding compartments, and the variable condensers are in shielding cans. The arrangement of the individual shielding compartments is such as to produce a satisfactory over-all shielding also. Shielding is seldom used with maximum efficiency; in a great many instances, shielding acts more as a loss, or efficiency-reducing element, rather than as a pure circuit isolator and efficiency-increasing form of construction. In this receiver, particular attention has been given to this point, and the elements of proper shielding gained through extensive experiments incorporating four, five and six stages of radio frequency amplification in special experimental set-ups, have been included in the "Seven Seas Console."

The amplification factor of the '01A type tube is 10, when tested as a complete amplification stage. The screen grid tube, however, develops a stage amplification of 30, at the same frequencies. The amplification of a tuned radio frequency amplifier using three '01A type tubes is 10^3 , or 1,000. At one time this was considered to be tremendous amplification and, in comparison with the attainable volumes at that time, it was considerable. However, as the gain-per-stage of the screen grid tube is 30, a three-stage amplifier using this type tube shows a total gain of 27,000.

Obtaining Selectivity

With a single tuned circuit and a voltage output relatively as high as this, the result would be the reception of several stations at one time, or "broad tuning". A multiplicity of tuned circuits, with properly proportioned input and output inductance values and coupling ratios, will develop more than sufficient selectivity. To obtain the correct amount of

selectivity (with the present status of station frequency allocation, a "separation of 10 Kc." is an official designation of selectivity), it is only a matter of engineering design. This is illustrated in the comparative graphs of amplification and selectivity.

In most modern receivers, it is the

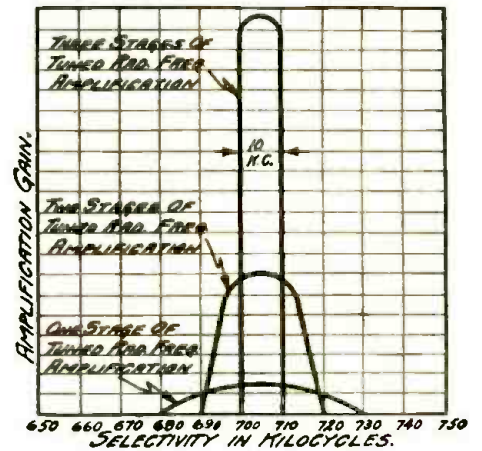

"Selectivity Gain." The selectivity (freedom from interference) in a radio receiver increases rapidly as each stage of tuned radio frequency is added. When too many stages are used, the extreme selectivity detracts from the quality of reproduction by cutting off the side bands. For all ordinary purposes three are very efficient and will provide 10 kilocycle selectivity between stations of equal signal strength (a reasonable distance away.)

practice to use a "dummy", or untuned input tube. The object of this tube is to permit the use of antennas of varying characteristics, without detuning of the single-shaft-controlled tuned stages due to this unknown condition which cannot be conveniently compensated for, in the design, by ordinary means. In the

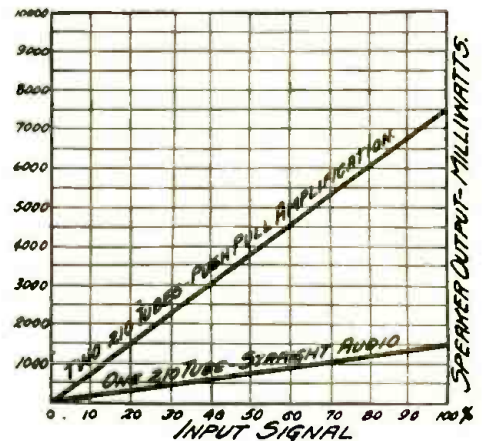

"Maximum Undistorted Reproduction." By using push pull audio amplification with two power tubes instead of one, the output is not simply twice that of one tube but actually five to seven times as much.

"Seven Seas" electric set, an antenna circuit tuning condenser has been included as part of the single dial control; compensation for antenna variation which will arise, as explained above, is then obtained by means of a variable antenna input coil coupling variation. This is not a panel control, but is adjusted at the time the receiver is installed and is not varied unless the antenna characteristics are changed.

The variable condensers required for properly tuning such a circuit are four in number. This represents four resonant circuits, although there are only three stages of radio frequency amplification. These four stages are the maximum permissible number, as indicated by the graph, for maximum radio frequency selectivity and minimum audio frequency distortion. When tuning to local station programs, it is not necessary to use two tuning controls; the set is a single-control receiver under this condition (the two tuning control drums inter-locking and operating as a single unit). When it is desired to increase the selectivity by tuning more accurately, or when it is desired to receive distant stations within the range of the receiver (in daylight, the average is about 500 miles; at night, 2,000 to 3,000 miles), the clutch can be released and the drums, controlling two variable condensers each, operated independently.

Engineering Details

It will be noticed that sub-panel wiring is used. This results in a neat appearance and at the same time increases the shielding effect of each stage, due to the absence of wires in the stage shields which could cause circuit coupling.

The screen grids are not individually bypassed, a single one-microfarad condenser sufficing. The control grids of the screen grid tubes are all biased with the same potential, a 425-ohm resistance, bypassed with a condenser, supplying a bias-voltage which is common to the three control grid tube elements. The screen grid voltage is variably controlled at the

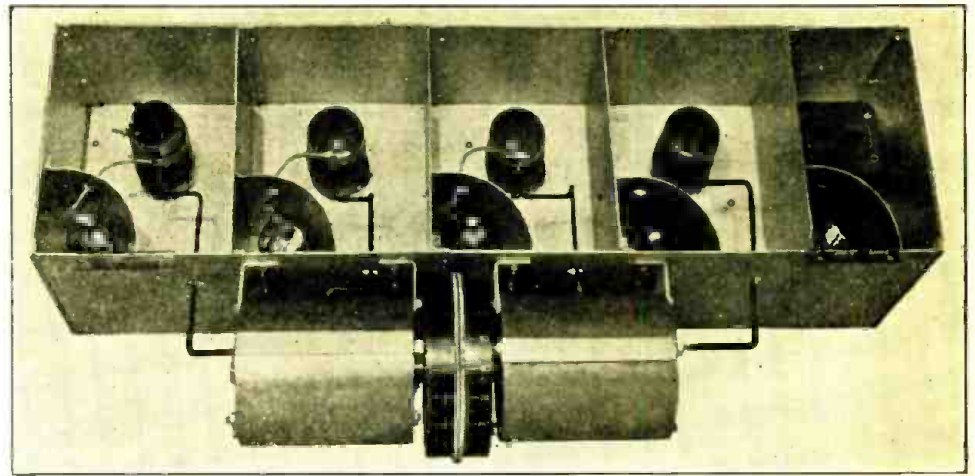

Parts layout of the receiver. The R.F. coil primaries are outside the secondary coils.

panel, the varying potential for the three screens resulting in an excellent volume control. Heater type screen grid tubes with 2.5 volt filaments are used.

An additional panel control constitutes the variable resistance which is in shunt to the secondary of the first audio frequency transformer. The purpose of this unit is to control the volume of the signal input to the single and push-pull audio stages.

It will be noticed that two type '81 tubes are used in the high voltage supply unit. A single tube of this type could be used, but the current output would not be sufficient to prevent motorboating. Many power amplifiers using type '10 tubes in push-pull specify only one type '81 rectifier. This arrangement is quite satisfactory where the current requirements are considerably below the demands of receivers of this type in which every effort is made to reproduce the lowest notes with full power (rather than "kill" them to satisfy a price standard).

The two volume controls included in the design function, one as a "radio frequency gain", to keep the radio frequency amplification at a level which will not

overload the grid-leak-and-condenser type of rectifier and the other, as an "audio frequency gain" control of the detector output to prevent overloading the audio amplifiers.

Although type '50 tubes are available as a special audio amplifier, the recommended and diagrammed design includes two type '10 tubes in push-pull.

The audio transformers used were selected as being the most satisfactory. An excellent response is obtained between 40 and 8,000 cycles. This unusually wide frequency reproduction has been made possible by the liberal use of bypass condensers which reduce inter-circuit coupling to a minimum.

The Push-Pull Circuit

The output transformer is of the "voice coil matching" type. As the dynamic "loud speaker" shown in the schematic circuit is an integral part of this console radio set, it is quite convenient to eliminate the voice-coil matching transformer which is usually associated with dynamic speakers (as purchased on the market).

That is, the last stage output unit usually has a high impedance. The voice-

(Continued on page 44)

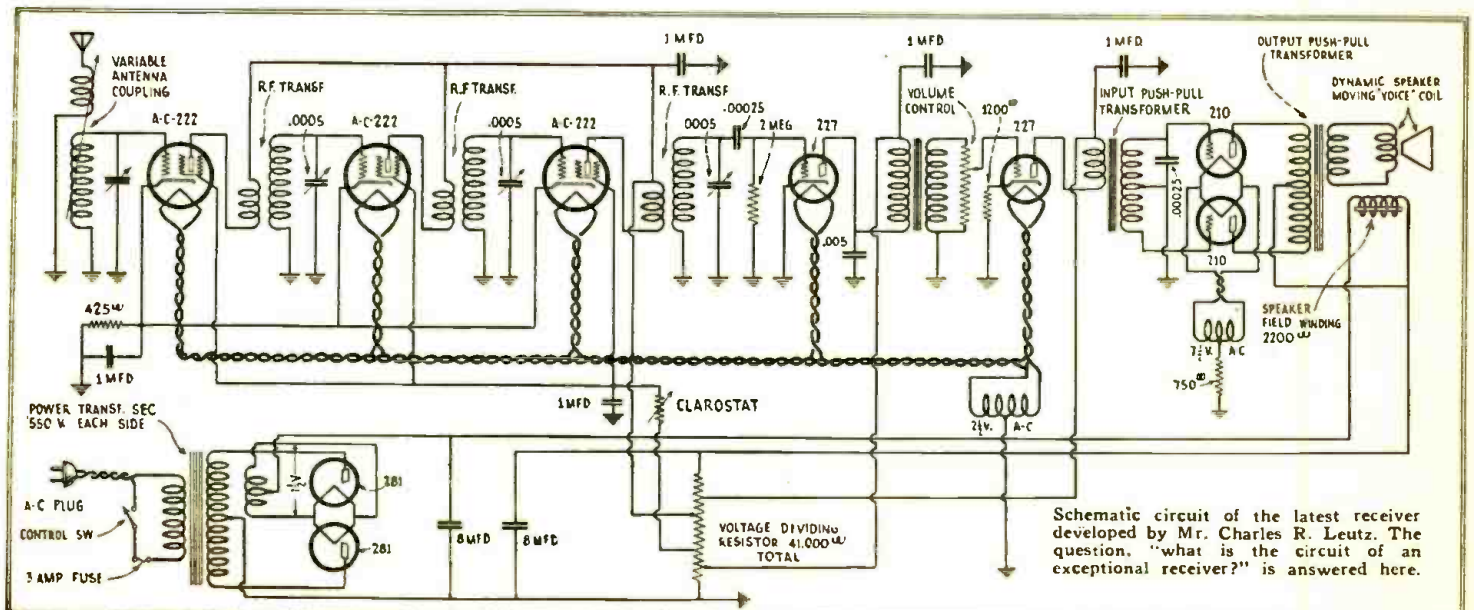

Schematic circuit of the latest receiver developed by Mr. Charles R. Leutz. The question, "what is the circuit of an exceptional receiver?" is answered here.

SHORT WAVE CRAFT

The Pilot "Super-Wasp" Receiver

By JOHN GELOSO*

A new circuit arrangement recommended to those who want something very much better than the average for short wave reception. Front view of the "Super-Wasp," a radio receiver

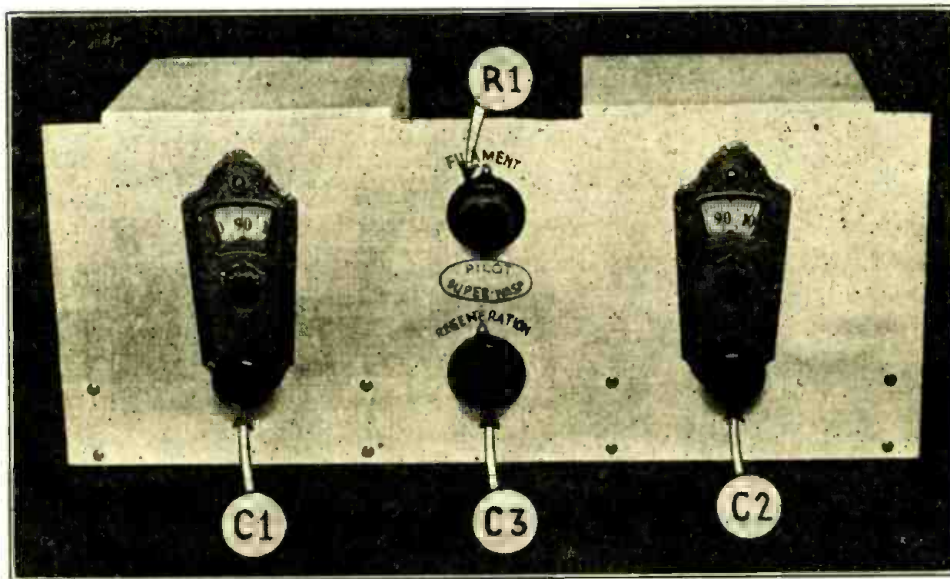

designed for reception on the frequencies between 600 Kc. (about 500 meters) and 21,428 Kc. (about 14 meters), by the exchangeable - inductance (plug-in coil) method.

THOUSANDS of radio fans throughout the country have assembled short-wave receivers that consist for the most part of a plain regenerative detector with one or two stages of audio amplification. A great many of them have enjoyed truly phenomenal results from their inexpensive contraptions, it being no particular trick for them to pull in the signals of broadcast stations in England, Holland, South Africa, Central America, Australia and New Zealand.

However, a goodly number of these short-wave experimenters have not been so successful, their 'phone reception being confined to American stations like W8XK, W2XAD, W2XAL and a few occasional amateurs. These people for the most part have had considerable experience with broadcast receivers, and they are asking a logical question.

"Why can't short-wave sets be improved by the addition of a tuned R.F. amplifier, just as the old straight regenerators were improved several years ago for broadcast reception? We have good screen-grid tubes and we have some good shielding materials."

Early last fall some of the radio kit

* Chief Engineer, Pilot Electric Mfg. Co., Inc.

producers made a half-hearted attempt at improving the straight regenerative receiver, which, for short-wave reception, has undergone absolutely no real

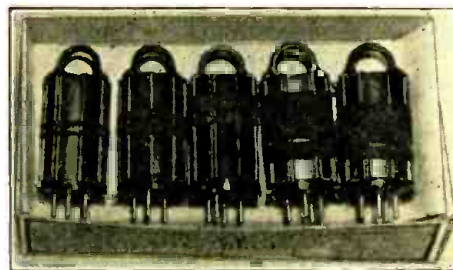
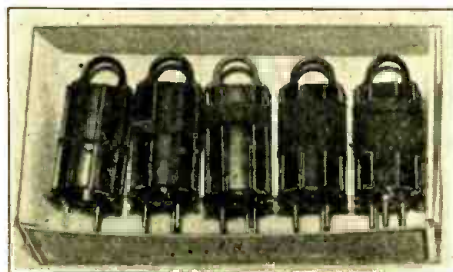

Upper row: Input coils for the '22 tube. Lower row: Output coils for the '22 tube. Rings molded with the ribbed coil forms allow of easy removal of the coils. This eliminates a source of damage possible with older coils not so made. This is a welcome feature.

improvement in the last five years. They put a '22 screen-grid tube ahead of the detector, but they did not shield it and they did not tune its input circuit. The grid of the tube merely floated uselessly across the aerial and ground, with a grid leak or a small R.F. choke keeping it company. The '22 acted merely as a blocking tube, its only real value being the elimination of dead spots in the condenser range caused by aerial capacity.

Kruse to the Rescue

The company, which was already marketing a successful short-wave kit known all over the world as the "Wasp", decided to tackle the problem, and obtained the services of a man who is unquestionably one of the foremost authorities on short waves in the United States. He is Robert S. Kruse, whose name is known and respected wherever radio magazines are circulated. With the cooperation of the engineering staff and particularly Robert Hertzberg, a member of it, he proceeded to beat down every one of the objections offered against tuned screen-grid R.F. for short waves, and they were able to demonstrate what they modestly think is the best short-wave receiver kit that has yet been produced for the amateur experimenter.

The new set, called the "Super-Wasp"

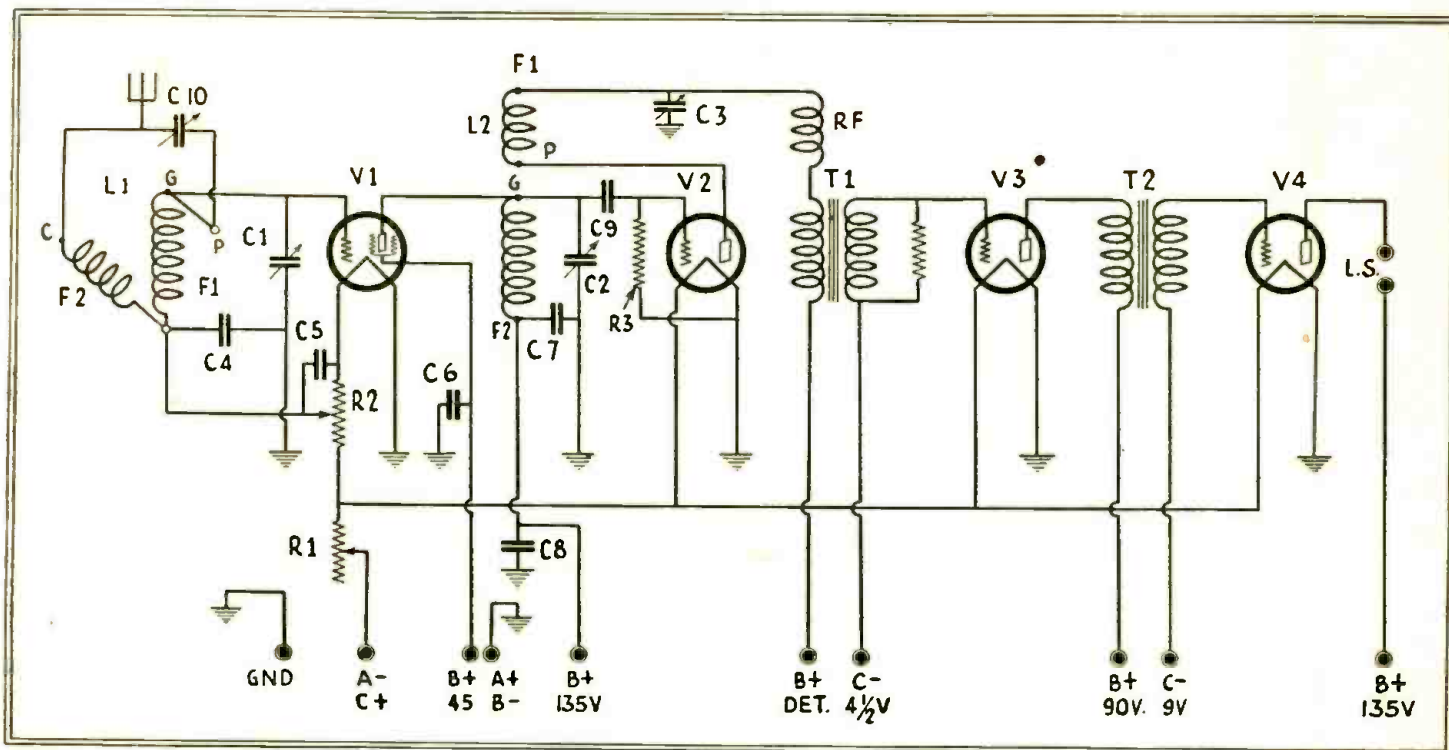

Schematic circuit of the newest in short wave units, the Pilot "Super-Wasp." This is a complete receiver capable of reception from distant stations and at "loud speaker volume," so called. Shielding is necessary to obtain efficiency in the first stage.

because it supersedes the old "Wasp," boasts of the following features:

- (1) It uses a tuned '22 radio-frequency stage that actually amplifies and that tunes as sharp as the proverbial razor. The tube is not a blocking tube; it is an amplifying tube.
- (2) It will tune down as low as 14½ meters and up as high as 500. Two sets of plug-in coils (10 coils in all) are supplied with it. Thus, it is an all-round receiver, and can always be depended on to produce some signals, on some wave-length. On the regular broadcast band it is the equivalent, electrically, of the famous Browning-Drake.
- (3) The increased sensitivity and selectivity provided by the R.F. stage make the reception of short-wave broadcast stations easier than with a highly critical straight regenerator.
- (4) It is doubly shielded, there being no interaction between the R.F. and the detector stages.
- (5) There is absolutely no hand capacity effect. If you have ever played with a cranky set of the ordinary kind you will know what a blessing this feature is.
- (6) The arrangement of the parts has been worked out so ingeniously that the whole outfit can be assembled and wired in one evening—and I mean an evening that starts at about 7:30 p. m. and ends well before midnight, not one of those flexible "evenings" that begins before supper and ends about the time the milkman's wagon comes clattering down the street.
- (7) It is cheap to build, the complete kit of parts, including the ten coils, costing less than \$30.

By examining the accompanying diagrams and illustrations you can obtain a good idea of the general electrical and mechanical arrangement. Briefly, what has been provided is this:

Details of the Circuit

The signals picked up by the aerial pass through the midget coupling condenser C10 and pass to a regular tuned input circuit connected across the grid

and filament of the '22 tube. The coil L1 is a plain solenoid on a form which plugs into a five-prong tube socket, while tuning condenser C1 is a regular .00016 mf. variable. On each of the four small coils (the largest tuning up to 200 meters) there is merely a single winding, but three connection pins for it in the base of the form. One end of the winding connects simultaneously with the G and P pins, and the other to one of the F

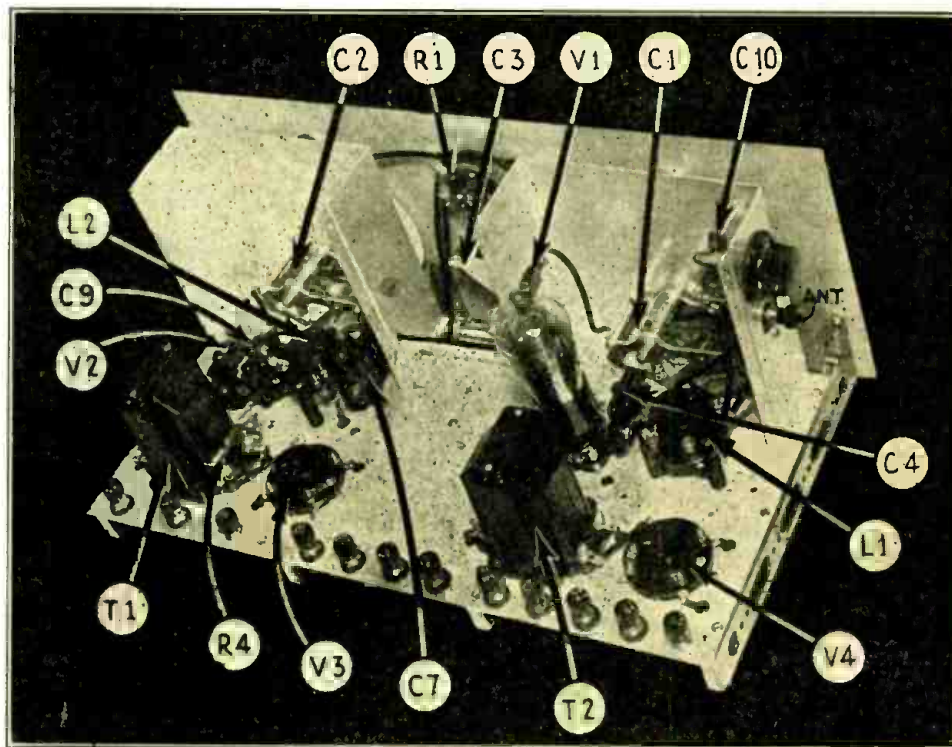

A rear perspective showing the unusual but convenient arrangement of the shields. Every part must be placed just right or the efficiency of the unit is reduced. The coils plug into the raised sockets.

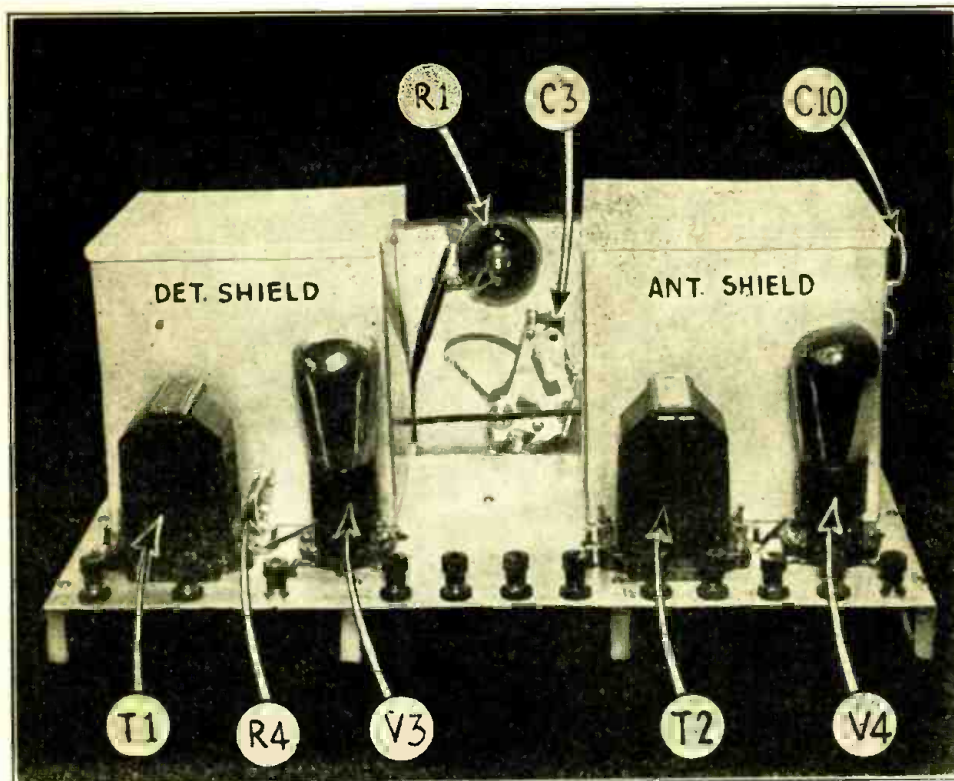

The "Super-Wasp." rear view. Television, music and code reception are possible with it, and from distant stations, with correct handling under satisfactory conditions. There are two tuning controls and one main amplification (regeneration) control.

posts. On the fifth and largest coil, which takes in the broadcast band, there is a primary in addition to the grid coil, connected to the *G* post and the same aforementioned *F* post. However, the bridging wire between the *G* and *P* posts is absent.

By means of this arrangement, the aerial is coupled to the tuning coils of the four short-wave inductors through the midget condenser *C10*. This condenser is too small for the 200-500 meter region, so when the largest coil is plugged in, it is automatically cut out of the circuit and the aerial coupled to the grid coil by means of the more adequate primary winding. There are no switches to be thrown, or wires to disturb.

The screen-grid tube *V1* is direct capacity coupled to the detector circuit in an exceedingly simple but effective manner, which was decided on after several other and more complicated methods had been tested thoroughly. The plate current for the '22 tube is fed right through the detector grid coil, being kept off the grid of the detector *V2* by the grid condenser *C9*. As the rotor of the tuning condenser *C2* is grounded to the aluminum chassis of the set, the *L2-C2* tuning circuit is completed by a .01 mf. condenser, *C7*. This condenser, in series with the .00016 mf. of *C2*, is too large to have any appreciable effect on the tuning, but prevents the "B" + 135 from short-circuiting against the framework. A similar blocking condenser, *C4*, is used in the R.F. stage to allow the grid of the '22 to be biased by the voltage drop across the tapped filament resistor *R2*.

The detector coils *L2* each contain two

windings, the usual grid and tickler coils. These also are plug-in coils which fit in a five-prong tube socket, four of the five available prongs being used.

The detector is made regenerative by the tickler of *L2*, the action being controlled by a .00025 mf. variable condenser, *C3*. The detector is followed by two standard transformer-coupled audio stages.

Mechanical Details

The mechanical layout of the parts in the final Super-Wasp is the result of many trials with seven different experimental models. The front and sub-panels are of heavy aluminum, accurately drilled for all parts. The components of the antenna stage—*C10*, *C1*, *L1*, *C4* and *V1*—are contained within an aluminum shield can of unique design. These cans, as shown in one photo, split down the center. First the condenser *C1* (and *C2* in the detector can) is fastened to one side and fitted to the dial on the front panel; the feet of the can are then screwed down to the sub-panel. As the can is free and open, the other parts can be mounted easily and comfortably. After everything is in place, the back half of the can is screwed down and the job is finished. Above is a back view of a completed Super-Wasp with the cans and their covers in place.

The condenser *C10* and the aerial binding post are mounted on the side of the antenna can. The socket that takes the antenna plug-in coils is elevated one inch above the sub-panel by means of three hard-rubber bushings. The blocking condenser *C4* is mounted directly to its electrical connection points by special

lugs supplied with it. The important R.F. leads have practically no length, yet the parts are not crowded.

The detector can, of the same size as the antenna can, houses the condensers *C2*, *C7* and *C9*, an elevated socket for *L2* and a plain socket for *V2*. *C7* and *C9* are also mounted by special lugs, and here also the R.F. leads are negligible.

The two audio stages fit neatly along the back of the sub-panel. The underside of the latter supports the .01 mf. by-pass condensers *C5*, *C6* and *C8*, and the '22 filament resistor *R2*. Notice in the picture how little wiring there is. The only long leads are filament wires, which don't count much anyway. There is so little wire because one side of practically all the parts is grounded directly to the aluminum framework.

The front panel, shown in one view, is plain but neat. It holds vernier dials for condensers *C1* and *C2*, and, in the center, the filament rheostat *R1* and the regeneration condenser *C3*.

Battery connections are made to a row of insulated binding posts along the back edge of the sub-panel. Separate "B" and "C" posts are provided for each of the audio stages, so that any combination of tubes may be used.

A filament rheostat is used instead of fixed resistors so that a man not owning a storage battery can run his outfit on dry cells. As the cells weaken, the rheostat can be turned up to keep the tubes working properly. The instrument also acts as a switch for the entire set.

A full-size working blueprint is furnished with the kit, along with a pamphlet containing detailed assembly instructions.

Results

Now that we have described the Super-Wasp, you will probably ask, "What will the set do?"

Well, predicting specific results from short-wave receivers is uncertain business. All that can be said is this: in direct comparison with several untuned screen-grid short-wave receivers of standard make, the Super-Wasp was so obviously superior in sensitivity and selectivity that none of the impartial observers called in to witness the tests even expressed a doubt about it. The screen-grid tube *amplifies* and the tuning stage *tunes*. These are the answers to the two questions asked of us most frequently during the preliminary experimental work on the set.

There are two tuning dials instead of one, but somehow or other this feature does not seem to cause any trouble. The set "handles" just like a Browning-Drake or any of its numerous variations, and that set certainly is familiar to many thousands of people.

In New York, in a location known to be utterly poor for short-wave reception, the Super-Wasp pulled in station 5SW, in Chelmsford, England, with fair loud speaker volume, and on ear phones gave excellent signals on other broadcast stations such as PCJ, in Holland, and NRH, a little amateur outfit in Costa

Rica, Central America. We won't even mention American stations like W8XK and the Schenectady group, or the hundreds upon hundreds of amateur and commercial telegraph stations. The range is unlimited; the operator merely has to shift coils and catch the stations at the right hours. Once he spots them on the dials he can bring them in regularly.

The Super-Wasp covers the short-wave channels quite completely. The wavelength ranges of the five sets of coils, which are fitted with handles of different color, for ready identification, are as follows:

Red Coils	14½ to 27 meters
Orange	26 to 50 "
Yellow	48 to 100 "
Green	100 to 200 "
Blue	200 to 500 "

The tops of the shield cans are easily removable, so the coils may be plugged in and removed without trouble.

The Necessary Parts

The following Pilot parts are used in the construction of the Super-Wasp:

- 1—Aluminum front panel, 7½ x 18 x 1/16 inches, drilled and engraved.
- 1—Aluminum sub-panel, 8 x 17 x 1/16 inches, drilled with all mounting and wiring holes.
- 4—No. 37 metal sub-panel brackets.
- 2—No. 1608 .00016 mf. variable condensers.
- 1—No. 1613 .00025 mf. variable condenser, with bakelite knob.
- 2—No. 1282 illuminated vernier dials.
- 1—No. 906 rheostat, 6 ohms.
- 1—No. 961 Tapped resistor, 15 ohms.
- 2—Special Super-Wasp shield cans, with all necessary mounting screws.
- 1—No. J5 midget condenser, 5 plates, with special bakelite mounting strip.
- 2—No. 931 audio amplifying transformers.
- 2—No. 212 five-prong sockets (for plug-in coils).
- 2—No. 206 four-prong shock-proof sockets (for '22 and detector tubes).
- 2—No. 213 four-prong sockets (for audio tubes).
- 2—Pairs grid-leak clips.
- 1—No. 758 3-megohm grid leak.
- 1—No. 750 100,000-ohm grid leak.
- 1—No. 50B fixed condenser, .0001 mf.
- 5—No. 59 fixed condensers, .01 mf.
- 1—No. 130 R.F. choke coil.
- 13—Bakelite-top binding posts.
- 10—Sets of insulating bushings for binding posts.
- 1—Package of hardware, including all necessary nuts, bolts, and washers for mounting of parts, soldering lugs, and special double-ended lugs for mounting of fixed condensers.
- 2—Sets of plug-in coils, made especially for the Super-Wasp.

In the construction of receivers operating on the broadcast wavelengths, it seldom makes much difference whether a certain part is placed exactly one way or

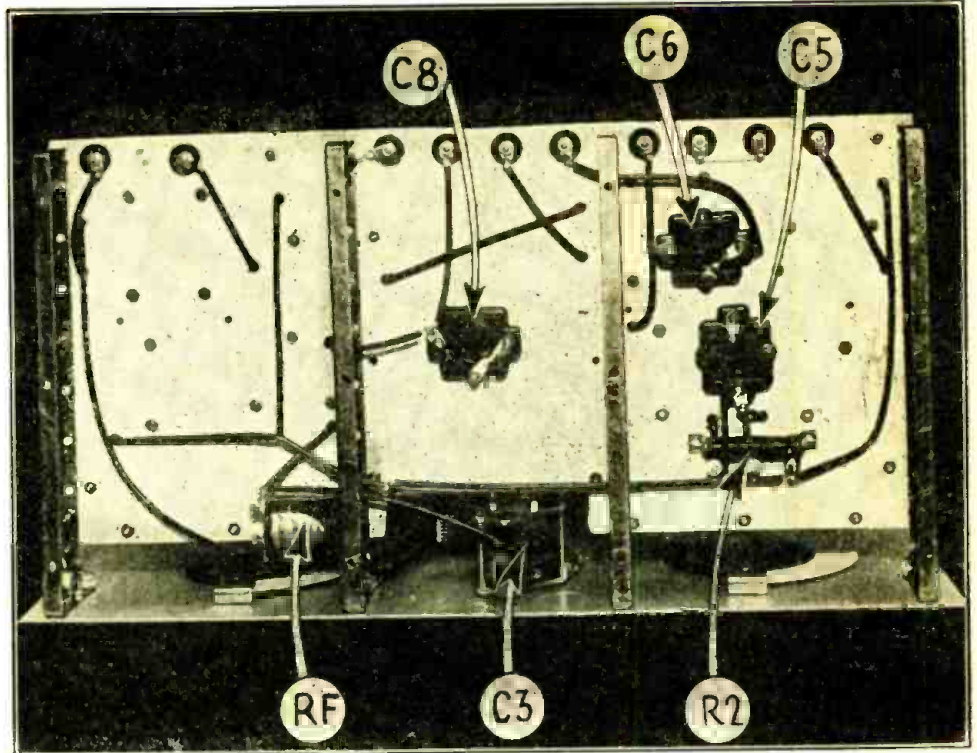

There is little wiring underneath the sub-panel, as this illustration shows. Four brackets supply rigidity necessary to prevent "wobulation" of signals on short waves.

another. However, in short wave operation it has been found that the conditions are more exacting and it will be inadvisable for the constructor to vary to any extent from the design recommended.

As many constructors will want to make their own short wave coils, the construction details are included in this article*

The reason this has not been done before is that there is considerable question as to whether the average set builder would be able to duplicate the performance possible with commercial coils. In fact, it may be very definitely stated that proper results cannot be obtained except by accident, for the simple reason that it is not possible to duplicate the construction of a coil even in the factory, except under the most rigid electrical inspection and machine supervision, where such coils are designed to be operated at wavelengths as low as 14 meters.

However, as an approximation of values, the data will probably be acceptable as a reference or basis for experimentation.

Pilot Short Wave Coil Data

INPUT TO '22 TUBE	
Color	No. of Turns
Red	4½
Orange	9½
Yellow	20½
Green	46¼
Blue	128

The last coil has, in addition, a primary of 29 turns spaced about one-eighth inch from the secondary.

The average outside diameter of the ribbed form is one and three-eighths inches.

OUTPUT OF '22 TUBE

Color	No. of Turns	
	Pri.	Sec.
Red	4	3½
Orange	6	7½
Yellow	7	17¼
Green	15	45¼
Blue	25	106

Both sets of coils are tuned with the same capacity variable condenser, .00016 mfd. The regeneration condenser value is .00025 mfd.

All the coils excepting the blue, or broadcast range coils, are wound with No. 24 D.S.C. wire; the blue coils are wound with No. 28 S.S.C. wire.

The spacing between primaries and secondaries of the '22 tube output coils is about one-eighth inch.

It is to be understood the number of turns indicated for the input coils is the secondary value, since these coils do not require a primary, as explained in the text, the signal being transferred by variable capacity coupling, found very satisfactory in the old "Wasp" receiver, rather than the more general inductive coupling standard for reception at the high broadcast wavelengths.

**The original coil data varied from the values given above, but improvements in design have resulted in the exact values listed. We are grateful to the Pilot organization for their cooperation with our readers interested in short wave reception. We predict for the "Super-Wasp" a greater sale than was had with the older short wave receiver. One interesting combination built up by experimenters was a superheterodyne using one of the older "Wasp" receivers as the pickup and another as the intermediate frequency amplifier. We would be glad to hear from experimenters who try an equivalent circuit using the new and much more efficient unit described in this article.*

It would not be amiss to advise beginners in short wave reception, that tuning must be done far more slowly than is necessary on the broadcast wave lengths. This characteristic condition on short waves can not be stressed too strongly: one "old timer" reports tuning in forty stations as against only eight which an inexperienced operator tuned to under similar conditions.—Ed.)



Manufacturers are invited to send to this department photos and descriptions of new apparatus



ANNOUNCING THE UY-224

A FOUR electrode, screen grid tube, Radiotron UY-224, embodying a 2.5 volt heater element which permits operation from alternating current will be placed on the market around May 1st by the Radio Corporation of America, it has been announced.

This new Radiotron is recommended for use primarily as a radio frequency amplifier in circuits especially designed for it, but it may also be used in special circuits as a detector or as an audio frequency amplifier.

The fourth electrode—the screen—in the new UY-224 makes possible the attainment of very high, stable amplification per stage.

Characteristics of Radiotron UY-224

- Plate voltage, maximum and recommended, 180 volts.
- Negative grid voltage, 1.5 volts.
- Screen voltage, maximum, 75 volts.
- Plate current, 0.4 milliampere.
- Screen current, not over $\frac{1}{3}$ of plate current.
- Plate resistance, 400,000 ohms.
- Amplification factor, 420.
- Mutual conductance, 1,050 micromhos.
- Heater, 2.5 volts.
- Heater, 1.75 amperes.
- Maximum overall, diameter, $1 \frac{13}{16}$ ".
- Maximum overall, length, $5 \frac{1}{4}$ ".
- Base, Standard UY (5 Prong).
- List price, \$4.00.

(The experimenter will welcome this tube which makes convenient, in A.C. sets, the high amplification possible with screen grid tubes. The recommended plate potential of this tube is 50 volts greater than the equivalent tube in the battery model, but this is not a disadvantage; the amplification is greater than can be obtained from the battery model and high voltages might almost be termed a "by-product" of A.C. operation. We await the interesting radio equipment experimenters will develop around the UY-224 and its companion tube in the Cunningham line.—Ed.)

A 0.125 WATT POTENTIOMETER

A NEW variable resistor designed especially for the purpose of volume control in radio receivers has been brought out by the Pilot Electric Mfg. Co., of Brooklyn, N. Y. It is made in four resistance ranges: 0-50,000 ohms, 0-100,000 ohms, 0-200,000 ohms, and 0-500,000 ohms.

With a potentiometer of the proper size connected in any one of several places in a receiver, the volume can be adjusted from zero to maximum with only one turn of the knob.

The instrument consists of a one-piece molded case of bakelite. The resistance element is a strip of non-hygroscopic material impregnated with a special chemical preparation. It is coiled inside the case, contact to its surface being made by a flexible phosphor-bronze ring slightly smaller in diameter than the

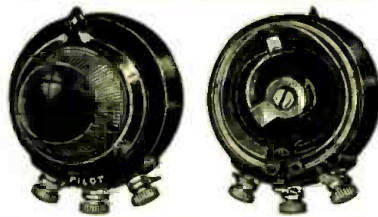

resistance strip itself. A button attached to a rotating arm presses a small section of the ring against the strip, making good electrical connection with it.

This unusual arrangement relieves the resistance strip of the frictional wear of the contact arm. The thin phosphor-bronze ring is made to press down lightly on the strip, and does not tend to rub off the surface of the latter. The overall resistance of the strip therefore remains unchanged, and is not affected by constant rotation of the knob.

Connections from the ends of the strip and from the contact spring are brought out to binding posts on the periphery of the case. The device may be used either as a potentiometer or as a straight variable resistor. The brass shaft is insulated from the contact spring which it controls, so the instrument may be used without change on metal panels. It mounts in a single hole. The back of the case is covered by a transparent disc of non-combustible material. The action of the contact arm and ring may readily be observed through this cover.

The instrument will safely dissipate .125 watt. This power capacity is more than adequate for a volume-control de-

vice, which is called on to handle currents of only slight value.

For example, it can be employed as an antenna potentiometer, in which position it exercises very effective control; as a means of controlling the voltage applied to the screening elements of screen-grid tubes; across the secondary of the first audio-amplifying transformer; or as a variable grid leak in capacity-coupled A.F. amplifiers. It is also useful as a regeneration control, for this purpose being connected across the tickler coil.

The retail price is \$1.50.

(This appears to be one satisfactory solution to the difficult problem of resistance variation smoothly, and, in most cases, between wide limits, with a minimum possibility of sudden change in the conductivity at some one point after a moderate period of operation. It remains only to learn whether "—a strip of non-hygroscopic material impregnated with a special chemical preparation." holds its calibration in service within its rating.—Ed.)

A 20-WATT VARIABLE RESISTANCE

A NEW variable resistor of the compression type, with a resistance range from 40 to about 10,000,000 ohms, has been brought out by the Pilot Electric Mfg. Company, of Brooklyn, N. Y. Its wide resistance range and its ability to handle 20 watts of power make it useful for many purposes in radio receivers. It is non-inductive and will steadily maintain the resistance value to which it is set by any adjustment of the knob. The change from minimum to maximum resistance is made through four turns of the knob.

The resistance material is a special non-packing compound, contained in a case turned out of a solid piece of brass. The outside of the case is ribbed like the cylinders of an air-cooled airplane engine, to dissipate the heat generated by the instrument during normal operation. In addition, the brass is black oxidized, for the same purpose.



The new resistor will carry 20 watts and will withstand voltages as high as

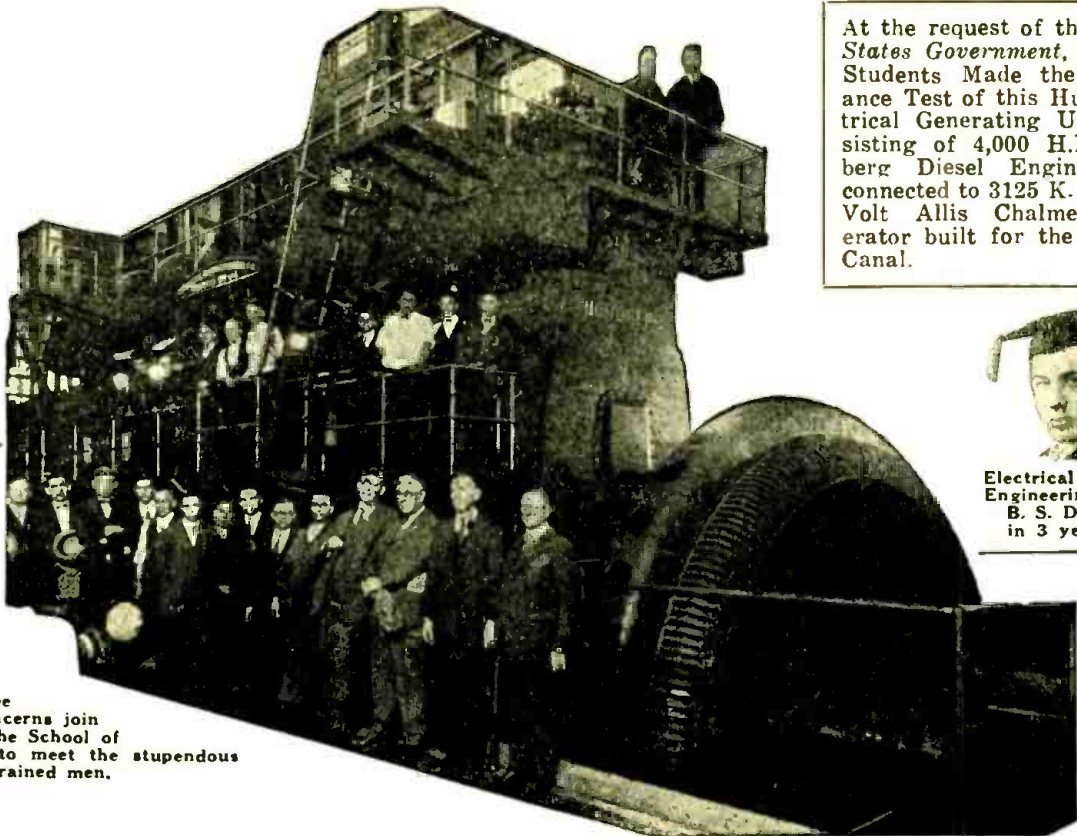

Big Milwaukee electrical concerns join hands with the School of Engineering to meet the stupendous demand for trained men.

At the request of the *United States Government*, S. of E. Students Made the Acceptance Test of this Huge Electrical Generating Unit, consisting of 4,000 H.P. Nordberg Diesel Engine direct connected to 3125 K. W., 2300 Volt Allis Chalmers Generator built for the Panama Canal.



Electrical Engineering, B. S. Degree in 3 years

Men of Action **WANTED FOR** Commercial Electrical Engineering

TAKES you out of the class of the common laborer of which there is always an overplentiful supply at cheap rates of pay. Makes you a Graduate Electrician, Junior Electrical Engineer, or Commercial Electrical Engineer in 12 short months. Puts you in line for a job where big manufacturers are actually pleading for trained men and glad to pay Big Salaries ranging from \$2,000 to \$10,000 a year. Not a dream—A DEAD SURE FACT! For 24 years we have trained men for the electrical profession and Our Graduates Have Succeeded in All Parts of the World. Our 12 months intensive training is the boiled down essence of what We Know fits men for big paying positions. It is work you'll love. No limit to advancement. Practical engineers teach you. They know What to teach and How to teach it, so you can earn money with

it. Hundreds of thousands of dollars worth of actual commercial machinery to work on in this school.

Uncle Sam Asks S. of E. OK!
Think of the opportunity to test plants such as this. The Nordberg Manufacturing Company is only one of many large concerns that is co-operating with School of Engineering students. This type of practical work, while in school, insures your future when you graduate. That's why our men are always in demand and always command big salaries. You can be one of these men if you ACT!

Earn While You Learn

By our special system you may earn part of your way while learning. Our Employment Department will help you secure a position to which you may devote a part of each day, spending the remainder at the school. This plan both solves the students' financial problems and provides splendid experience at the same time. Low tuition fee. Board and room reasonable. Daily Broadcasting WISN (formerly WSOE). School Orchestra. Fraternities.

institution and the great opportunities that lie before you. Find out about our specialized method of training and the details of our "Earn While You Learn" plan.

Radio and Electrical Refrigeration

Learn in three months—just 90 days and you can be one of the new group of trained men who will guide and develop the newest and best

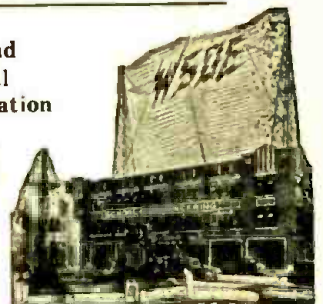

paying of America's gigantic industries. Radio and Electric Refrigeration are tremendous money makers for the trained man who gets into the game early. Experts are needed for big, responsible, well-paying jobs. We train you quick and help place you in a good position. ACT NOW!

FALL TERM OPENS NOW

School of Engineering of Milwaukee
Dept. R. C.-729, Milwaukee, Wis.

Without obligating me in any way please mail free Photo Story book, "Rise to Success Through Electricity" (just off the press), and NEW Bulletin regarding the course I have marked with an X.

- Commercial Elec. Eng. Elec. Refrigeration for High School Grad. Radio 1 year
- Commercial Elec. Eng. Armature Windinz Others 1 to 2 years Light, Heat & Power
- Elec. Eng., B.S. Degree 3 yrs. Practical Electricity Home Lab. Service
- Automotive Elec. I am Interested in your Earn While You Learn Plan.

Name Age

Address

City State

Education

SCHOOL of ENGINEERING of Milwaukee
Founded 1905 R. C.-729, Milwaukee, Wis.

Write for FREE Catalog
Write today for our free, illustrated catalog. Read about this wonderful

500 without internal sparking. It is 2 $\frac{1}{8}$ inches long overall and 1 $\frac{1}{8}$ inches in diameter, and mounts in a single hole. A black bakelite adjusting knob is provided.

The instrument may be used in "B" power packs for control of the output voltages; as an oscillation control in several different positions in R.F. circuits; as a volume control across the antenna circuit or in the audio amplifier; and as a regeneration control across the tickler or in series with the "B" lead to the detector tube. It is also valuable as a means of controlling the local exciting current through a neon-gas television lamp.

The retail price is one dollar.

(Variable resistances with the range of this new resistance have been available before, but it has not been easy to obtain such a resistance with a steady value,—under what would be called "normal conditions," the older resistances would often develop variation of resistance which manifested itself as loud crackles and generally poor operation. If this resistance will remain as constant in value, at the higher resistances, as we are led to expect, there should be considerable demand for the item.—Ed.)

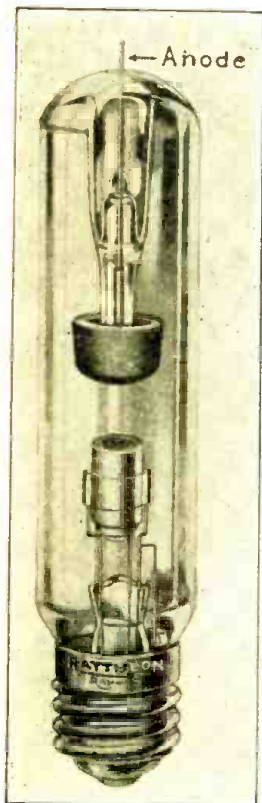

TYPE RAY S TUBE

A NEW tube, the Type Ray S, has been announced by Raytheon. The Ray S will be of primary interest to transmitting amateurs, since it is a high voltage rectifier. The constants follow:

Max. Height (overall).....	8 $\frac{5}{8}$ in.
Max. Diameter	2 $\frac{1}{4}$ in.
Fil. Volts	5.0
Fil. Amps.	5.0
Max. Reverse Peak Voltage..	8,500.0
Max. Current Peak Amps...	0.750
Starting Volts	50.0
D.C. drop across Rectifier...	17.0
Base	Mogul
Net Price	\$25.00

This tube is designed to supply from 2,000 to 3,000 volts and current up to 300 mils. With correctly designed filter, it will supply the plates of the X-852, X-860, V-861 and V-204A (transmitting) tubes.

The particular features of this tube are: low voltage drop; high potentials; high current; high efficiency.

(This rectifier holds little interest for the set builder. In a few instances, constructors may desire a tube with the above characteristics as part of the power equipment for a Public Address System or an Auditorium (type) Amplifier in which the V-204A tube is used.—Ed.)

HONEYCOMB COIL HOLDER

A FEW years ago, American amateur constructors would have welcomed a holder of the design worked out by Oskar Selinger, Berlin, Germany. There is very little de-

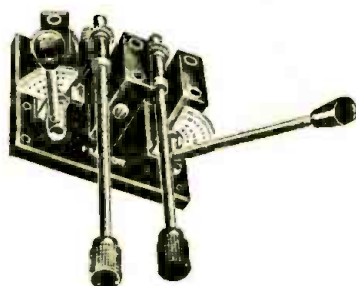

mand here for apparatus to be used with honeycomb coils, but those experimenters who listen to long wave transmissions through the medium of these coils, will note the graduated scales which make it readily possible to duplicate the coil couplings at any time.

NEW SPEAKER

THE new reproducer introduced by Aktiengesellschaft für Elektrizitäts-Ausführungen, Berlin, Germany, is quite futuristic. The three verticals, however, are a relief of the flat appearance of the tapestried front surface. This is a commendable effort

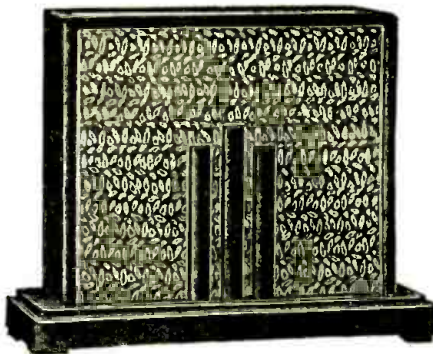

to get away from the appearance of a loud speaker, in the usual sense. We have no information as to its acoustic qualities, but the fairly large proportions promise good results.

THE TYPE RAY SX866 RECTIFIER

THIS, too, is a product of Raytheon. It is designed for supplying 1,500 to 2,000 volts at currents up to 250 mils with suitable filters and is especially adapted for supplying the plate potential for X-210, X-852, X-860, V-211 or V-203A tubes.

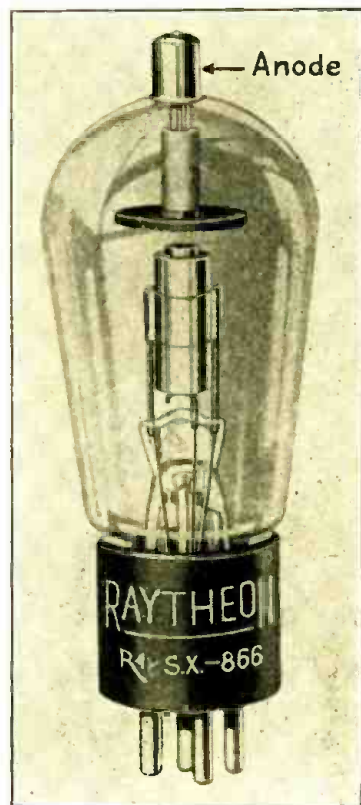

Within its rating, it has the same efficiency classification as the Ray S.

It is interesting to note the following service information: "When rectifiers are first received it may be found that in shipment mercury was spattered on the electrodes. It is desirable that the rectifier be run for approximately fifteen minutes before applying plate voltage in order to properly distribute the mercury. After the rectifier has once been placed in service it will not be necessary to repeat this process."

Raytheon was the first one of the "independents" to announce a patent agreement with R.C.A. which permits them to use the developments of the associated tube laboratories of R.C.A.

The type Ray SX866 rectifier should prove of considerable interest to set builders, as it has the following characteristics:

Max. Height	5 $\frac{7}{8}$ in.
Max. Diameter	2 $\frac{3}{4}$ in.
Fil. Volts	2.5
Fil. Amps.	5.3
Max. Reverse Peak Volts...	5,000.0
Max. Current Peak Amps...	0.600
Starting Volts	50.0
D.C. drop across Rectifier...	12.0
Base	Std. X
Net Price	\$12.50

A noteworthy point is that the Ray S and Ray SX866 do not show a variation in output with a heater voltage variation of 20% plus or minus.

RADIO'S - GREATEST - BARGAINS

On this page are listed some of the foremost bargains in radio merchandise ever offered. Tremendous savings on reliable products. Send us your name and address for big, FREE monthly bulletin of radio specials.



Let this page be your buying guide. We assure you that you can get no better bargains anywhere. Order from this page today—Send either 25% of the total purchase price if C.O.D. shipment is desired, pay on delivery, or remit in full with order. DEDUCT 2% CASH DISCOUNT IF FULL REMITTANCE IS SENT WITH ORDER!

SUPER 171 ABC ELIMINATOR

Supplies fixed voltages of 22, 90, 135, and 180 volts, and a variable voltage of 22 to 90 calibrated at 22, 45, 87, and 90 volts. 1 1/2 volts at 4 amperes, 2 1/2 volts at 3 1/2 amperes, and 5 volts at 1/2 ampere—ample enough for five



220, two 227, and two 112A or 171A tubes. Crackle brown steel case 13" long, 5 1/2" high and 3 5/16" wide. Completely assembled. Ready for immediate use! Requires one 280 Tube. YOUR NET COST \$14.90 Less List Price \$46.00.

SUPER 210 AND 250 ABC ELIMINATOR

Uses one 281 rectifier and supplies 22, variable 45 to 90, 135, and 425 volts of B, and 1 1/2, 2 1/2, and 7 1/2 volts A.C. for tube filaments. Completely assembled. Ready for immediate use! YOUR NET COST \$24.95 Less List Price \$58.00.

The NEW 245 SUPER POWER TUBES

Produce almost uncanny volume and quality of reproduction! Set manufacturers are redesigning their audio amplifier circuits so as to use these marvelous tubes. However, these improved sets will not be available until next fall.

By assembling (15 minutes enjoyable work) our **RADAX 245 COMPACT KIT** you can modernize ANY Radio Receiver, by installing one or two of these 245 tubes. Be 6 months ahead of the crowd! Imagine! you do not have to purchase other parts—your present receiver remains untouched!

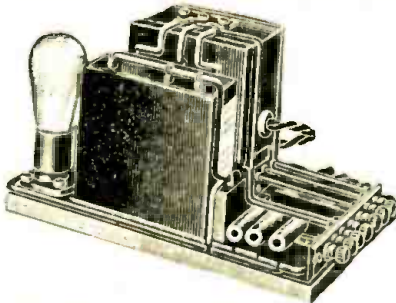

If you are a lover or connoisseur of perfect musical reproduction (and who is not?) you will receive \$1,000 VALUE FOR ONLY

\$12.90
(List Price \$42.00)
Requires one 280 Rectifier Tube.
In Stock: CX or Arcturus 345 tubes. List \$3.50

NOTE—If your receiver does not employ 2 Push-Pull Transformers, by all means install the Special Compact, equipped with 2 Push-Pull Amplification Transformers! With this model you do not use your present last audio stage. A few moments to install! All "A," "B" and "C" current requirements self contained! The finest receivers this year will use two 245 Power Tubes in Push-Pull!

Yours for Only \$8.50 Additional
Requires two 245 Tubes and one 280 Rectifier Tube.

SILVER-MARSHALL SARGENT RAYMENT No. 710 RECEIVER

7 TUBES. COMPLETELY ASSEMBLED. Station after station, near and far, DX and local, literally pop in and out with the positive, clear-cut selectivity that lets you get a station for every ten-kilocycle channel—95 to 100 stations in an evening under favorable conditions. Thick aluminum shielding and chassis, finished in



satin silver. Consists of five sharply tuned circuits in a four-stage screen grid B. F. amplifier, all tuned by a single illuminated drum, and each stage provided with individual verniers. Tubes required are two 112A, four 222, and one 171A, or one 250 Super Power Tube. 28" long, 12" deep, 8" high. YOUR SPECIAL NET COST \$94.00 List \$175.00

FREE — FREE — FREE
With every purchase of one of these fully assembled receivers, one of our Super 250 ABC Eliminators described on this page! There are no strings to this offer! We mean just what we say. It is our mighty bid for your valued patronage!

A Big Scoop—Hammarlund A.C. Sets

Completely Wired — Uses 250 Power Tube in Last Audio Stage!

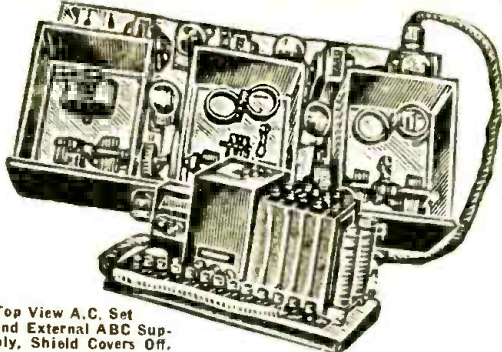

Top View A.C. Set and External ABC Supply. Shield Covers Off.

The circuit employed uses two shield grid tubes working at maximum efficiency, followed by a standard detector and two stage transformer coupled audio amplifier. The special "tuned-grid, tuned-plate" circuits employed in the radio frequency stages are responsible for the receiver's marvelous "pick-up" and selectivity. These stages are really band-pass filters, both plate and grid coils of each stage being tuned to exact resonance by separate variable condensers. Each stage is individually and completely shielded by special shields designed particularly to eliminate eddy current losses and preserve the desirable low resistance properties of the circuit. All parts are mounted on a ready drilled cadmium plated steel chassis with welded corners and of heavy construction. The tuning controls consist of two illuminated drum dials, one used as a separate control for the antenna coil and the other to tune the two filter stages. An all-electric radio ready to plug in the light socket. Ready for immediate use! Tubes required: two 222AC, two 237, one 250, one 281. List Price \$171.00. YOUR NET COST \$99.00

FREE! With every order for one of these assembled A.C. receivers, we will include, AT NO ADDITIONAL COST, a \$58.00 Super 250 Power Pack ABC Eliminator. No other radio house can match this tremendous offer!

Radax 171 Compact Eliminator Kit

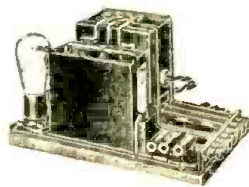

Supplies B power for an entire receiver, total: 200 volts. Can be assembled in less than 30 minutes. Requires one Raytheon Tube (\$2.65 extra). List Price \$33.80. YOUR NET COST \$8.90

Silver-Marshall No. 720 A.C. Screen-Grid Kit

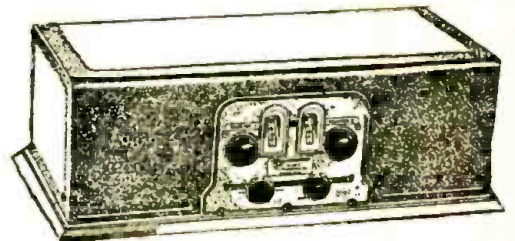

Consists of three stages of radio frequency amplification, using screen grid tubes, followed by a super-sensitive detector and two stages of Clough high gain audio frequency amplification with power output tube—112, 171, 210 or 250 type being optional. The B. F. stages are individually shielded in separate copper stage shields. All parts assembled upon an accurately pierced metal chassis in an hour, and the wiring is simple and direct. Tubes required: three 222AC, two 227, one 171A. (All makes in stock—discount 40%.) List Price \$77.00. YOUR NET COST \$46.20 Metal Cabinet Illustrated, \$5.55 extra.

SPECIAL INDUCEMENT—If you purchase this kit with the metal cabinet, we will sell you one current supply for this exceptional kit—certainly, a harmonious combination. It is folly to pass up this astounding offer!

SILVER-MARSHALL No. 720 SET EQUIPPED WITH A 250 POWER TUBE
Completely assembled. Power Pack Included, as well as metal cabinet. Tubes required: three 222, one 250, one 281, one 112A, one 201A. Capable of reproducing terrific volume, less any distortion! READY FOR IMMEDIATE OPERATION. AN OUTSTANDING BARGAIN FOR ONLY \$69.00

RAWNER RADIO AND TELEVISION COMPANY

142 R Liberty Street, New York



AN ODD UNIT

THE Powertone Electric Co., New York City, has developed a low priced "wave trap" for which considerable is claimed. However, there is considerable justification for some of the claims. The sliding arm and a fixed condenser act to tune the instrument.

The antenna lead is broken and the unit inserted in the lead. As the "slider" is swung across the coil the circuit resonates at various points in the broadcast range. The result is a considerable increase of signal strength of weak stations; or, an interfering station can be reduced in volume, instead. The former adjustment must be made for each station, while the latter adjustment may remain fixed (for that station). The price is one dollar.



SIMPLE PLUG—VOLUME CONTROL

ALSO from Germany comes a very neat speaker plug and volume control. Instead of adjusting a knob, a lever is moved for control of the volume. Of course, the control consists of a variable resistance in shunt to the loud speaker leads. (There is another way of arranging this control, but it is not in general use as yet. It is known as a compensated or balanced impedance control whereby an equalized condition is held, regardless of the reproducer volume, but this is an American development and is not in use in Europe, so far as we know.)

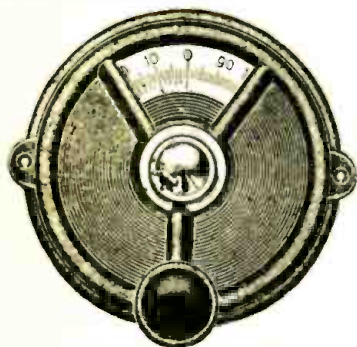

NEW VERNIER DIAL

IN the vernier dial by August Fullgarbe and Co., Berlin, Germany, we find another and successful effort to relieve the hard appearance of a large-surface dial. Mechanically, the dial is almost identical to our old "Marco" instrument; the appearance, however, due

to the illusion caused by the moulded radials, is quite different. The ratio is 18 to 1.

THE SI-LEN-SER

IN this device, the Truetone Sales Company of New York City offers an improved line-noise filter which has proven very effective in use. While it comprises two special, tapped impedances, a resistance, and a center-tapped capacity bank, these components

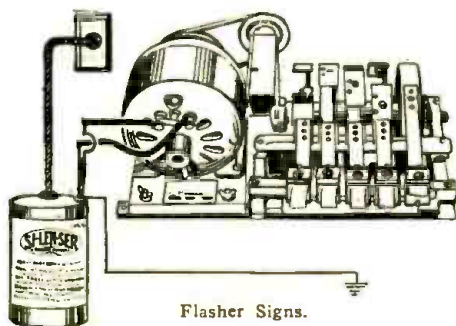

are contained in a shield 5 inches high, and 3 3/8 inches in diameter, externally. While the weight is but four and one-half pounds, not every service man will



care to carry such an item as regular route equipment. However, the well-equipped shop will find it profitable to demonstrate this "noise filter" in the instances where interference is being experienced from: (1) D.C. to A.C. rotary converters; (2) electric refrigerators;

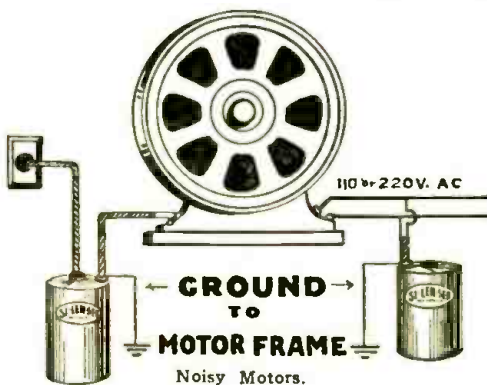

(3) dial telephones; (4) sparking electric household appliances; (5) power-line leakage noises; and, other electrical disturbances which do not arrive via the antenna, as the illustrations indicate.

LINE VOLTAGE CONTROL

ASERIES resistance to be inserted in the supply line to electric radio sets has been developed by the Insuline Corporation of America, New York City.

The unit is wound with a special resistance wire which maintains a relatively constant value regardless of the heating. To prevent shorting, the wire is covered with an asbestos compound.

Heat radiation is obtained by the use of a perforated metal case.



The unit is of the reducing type. That is, it reduces the line voltage to a lower, and more safe, value. (With a low line voltage there is no value in adding this unit as it will only reduce the line voltage still more.)

It has been observed that the choking effect of the inductance formed is sufficient, in some cases, to noticeably reduce the clicks and crackles originating from various line supply devices.

Known as the Antennavolt, another model may be used both as a limiting resistance for the electric receiver and as an antenna (as an antenna condenser has been built in). The antenna lead of the radio connects to a binding post on the unit and the line plug of the radio plugs into the plain Resistovolt. The former is priced at \$2.25 and the latter at \$1.75.

A.C.—D.C. VOLTMETERS

A. M. FLECHTHEIM & CO., New York City, are offering high resistance voltmeters in three models.

They are the Type AV300vDC, Type BV500vDC and the Type CV600vAC& DC.

Respectively, the prices are, \$6.00, \$8.50 and \$12.50.

The front-to-back dimension is 1 1/2 inches; the over-all diameter, 2 3/4 inches and the face diameter, 2 1/2 inches.

They operate on the electro-dynamic



principle. The accuracy is said to be within 2%, a figure that is, in part, made possible by the use of a special grade of wire for the series resistances. Connecting instruments to the current supply in the reverse direction will not harm them. Resistance value is 200 ohms per volt. The test prods are insulated and protected with casein in colors; red for positive and black, negative.

A Novel Dynamic Reproducer

Two new and distinctive developments which add to the value of the audio channel of any receiver

By CLYDE J. FITCH

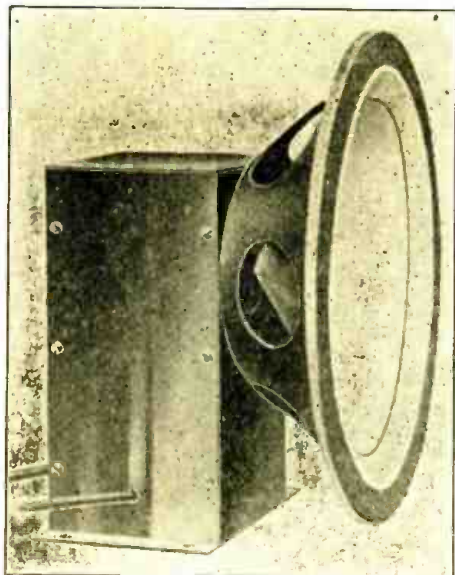

Fig. 1—The "swing past" idea in reproducers, which eliminates the possibility of rattling.

THE popularity of the dynamic cone speaker is without doubt due to its ability to reproduce bass. And this in turn is due to the fact that the cone is free to move a comparatively great distance, in the neighborhood of one-quarter inch. The ordinary variety of dynamic reproducer has a coil attached to the cone apex which moves longitudinally in a magnetic gap, crosswise with the lines of force, with the path of motion limited only by the restraining action of the delicate supporting and guiding springs.

New Armature Construction
In the reproducer illustrated, instead of a coil moving lengthwise in a magnetic gap, an armature, under the influencing action of four fixed coils, is arranged to move longitudinally in the gap. Thus, the full one-quarter inch dynamic movement is possible.

This is best shown with reference to Fig. 2. Here we have the field coil *F* that gives us the steady electromagnetic field *N-S* across the slotted pole tips. This field coil of course is energized as is the usual practice with dynamic speakers, either from the 6-volt "A" battery or from rectified alternating current. In this speaker, only five watts of electric energy are required to energize the field.

The voice coils, four in number, are placed over the four projections of the pole tips, as shown. These coils are all connected in series and connect to the secondary winding of the output transformer, which is mounted in the base of the speaker. Only a few turns of bare copper ribbon insulated with glassine paper are used for these coils. The impedance of the series matches the output impedance of the transformer, and the transformer is designed to operate from type '12, '71, and '10 tubes.

The voice coils are connected so that during one-half cycle poles 1 and 2 attract, and poles 3 and 4 repel the armature, causing it to move forward, and the reverse half cycle causes it to move backward, thereby imparting sound vibrations to the cone. The armature is held in position and guided in its path

of motion by the side supporting springs. It fits in between the pole tips with little clearance, so that as it vibrates, the area of the gaps between the pole tips and the armature varies, rather than the length of the gap, as is the case with ordinary magnetic units. With this construction, it cannot chatter against the pole tips.

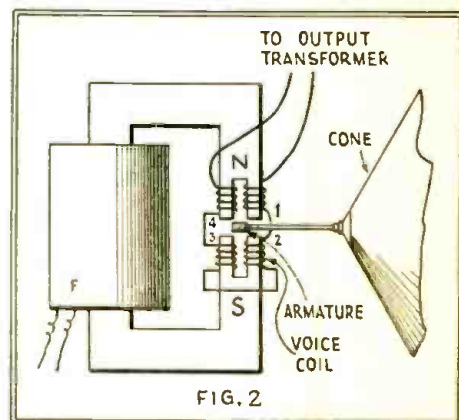

The application of a new idea in reproducer design is illustrated above. This includes a "field coil," a moving iron armature, and four fixed voice coils connected in series. The completed chassis includes a cone.

The cone is seven inches in diameter, mounted on a nine inch housing. Thus, the speaker can be mounted in a cabinet or on a baffle board. Either cabinet or baffle is necessary for best reproduction.

The fixed voice coil construction has many advantages over the older, moving voice coil reproducers.

And now, the "Detector Booster"

THIS new device should be of especial interest to radio experimenters during the coming summer months when reception is not as good as it might be. As the name indicates, it boosts the output of the detector tube, making the set more responsive to distant stations and bringing the volume of weak stations up to normal loud speaker volume.

To use the "DETECTOR BOOSTER," simply remove the detector tube from the set and insert it into one of the sockets of the booster together with another 201-A or 301-A tube in the other socket. Then insert the four-prong plug of the booster in the empty detector socket of the set, and connect the free wire of the booster to the detector "B" battery binding post of the set. Imme-



The "Detector Booster." With this introduction by Mr. Fitch, an unusual device makes its initial bow to the radio set user, whether he be constructor, service man, experimenter, or "B.C.L."

diately, the volume of all stations increases and stations that could not be heard before are easily tuned in.

There is nothing freakish or unusual about the amplifying action of this device. The additional tube required with the booster amplifies the detector output from 5 to 10 times and feeds it into the

regular audio amplifier and speaker; thus an additional stage of amplification is added.

Due to the simplicity of the device it can be removed or inserted in a jiffy. On special occasions, or at parties when greater volume is desired or the particular station wanted is too weak the booster can be plugged into service. For local reception it can be removed, so that the additional filament current required for the extra tube need not be used all the time.

In some instances, it may be found that a "hi-mu" tube is desirable in the unit.

The booster illustrated is for battery operated sets. For electric sets a special booster using two heater type tubes is made.



RADIO CRAFT KINKS

RADIOCRAFTSMEN:

HOW good are you at remembering the thousand and one little things that occur during a day, a week, or a month of experimenting, designing, constructing, wiring and testing of radio sets and parts for yourself or your friends?

Everyone has an equal chance to be awarded one of the two copies of "The Radio Amateur's Handbook" (A Manual of Amateur Short-Wave Radiotelegraphic Communication: contains 200 pages chock-full of the things you want most to know; right up-to-date and absolutely the best book of its kind obtainable), which are to go to the two readers of Radio-Craft who send in the greatest number of contributions to this department in one month.

All accepted material, will, in addition, be paid for at space rates.

The correct address is:

Radio-Craft Kinks Department,
c/o Radio-Craft Magazine,
98 Park Place,
New York City.

EXTENDING THE RANGE OF YOUR METER

By L. B. Robbins

WITH the addition of higher power to radio receivers many of the meters in the older sets are incapable of registering the higher power. Yet these same meters, if of an efficient and reliable make, can be easily adapted to read practically as high a voltage as is necessary. The entire procedure is simply one of adding a resistance of the proper proportions in series with the circuit of a voltmeter or shunting a resistance across the terminals of a milliammeter.

All resistors must be of good make and reliable. For voltages under 500 they can be the common receiving type so long as their reading is within a reasonable degree of being correct.

Suppose, for instance, you wish to extend the reading of a voltmeter reading

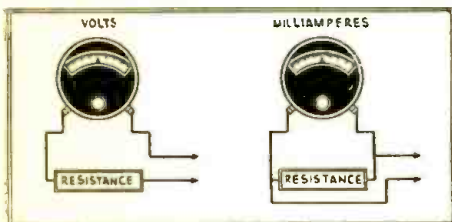

from 0 to 100 to read up to 500 volts. That is, you wish to make the future scale five times that of the former. First you must determine the internal resistance of the meter. This can easily be found from the catalogue of the maker, or by measuring the resistance with suitable instruments. When the ohms per volts is once determined the rest is simple. Calculate the complete resistance by multiplying the complete scale reading by ohms per volt. Suppose, for example, the resistance per volt is 100. Then for the 100 volts the total resistance will be 10,000 ohms. This represents one-fifth of the total resistance necessary. Four times 10,000 ohms will then be 40,000 ohms, the necessary additional resistance to increase the reading to 500 volts, full scale.

Connect this resistor to one of the meter terminals in series with the battery circuit. With the battery at full voltage the meter hand should go over to 100 which will actually mean 500 volts. Step the battery down 100 volts at a time and note the position of the hand, marking it on the scale at each 100 volts. The deflection of the meter, multiplied by five, gives the correct reading.

By using a variable resistance a meter can be prepared to read full scale from any voltage source by making various measurements, using the variable resistance at different settings.

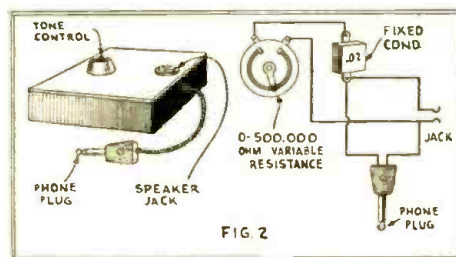

TONE CONTROL BOX

THIS may be made as illustrated in Fig. 2. The pictorial schematic indicates a fixed condenser of .02 mfd. capacity in series with a variable resistance. This resistance must be noiseless.

Many dynamic loud speakers sound harsh, due to the presence of very strong high frequencies. The modern dynamics have this tendency the least, as they ordinarily have a high frequency cut-off obtained either mechanically or electrically. The Tone Control Box illustrates one way of doing it electrically when the loud speaker does not contain such compensation.

The exact dimensions of the completed

unit will depend upon the particular parts used.

As the resistance is lowered, the high notes are by-passed more and more, with the final result,—very drummy reproduction.

The unit connects between the radio set and the loud speaker. The loud speaker plugs into the jack and the Tone Control Box plug is plugged into the jack on the radio set; of course, the plug is not necessary if the receiver has binding post provision for the loud speaker cord tips. Too, binding posts may be used on the Tone Control Box in lieu of a jack.

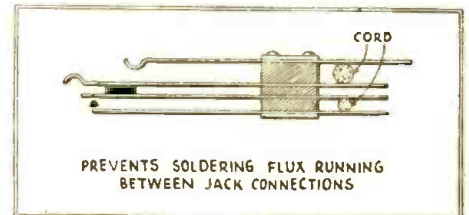

A SOLDERING AID

IT is often experimenters want to solder loudspeaker jacks and other instruments having soldering lugs arranged in a similar way; some anti-capacity switches have the connection terminals placed close together.

If a piece of cord is temporarily put between adjacent terminals, solder and soldering flux cannot run between the two connections.

If an acid flux is used, the flux can cause considerable leakage by saturating the material insulating the connections, if this material is absorbent; or, by resting on its surface if it is not absorbent. This trouble is eliminated by using the cord. Aside from the electrical considerations, it looks much better *sans* flux.

The good wireman will always clean the connections, after soldering the leads. The most convenient way to do this is to wash the joints with alcohol. A small brush may be kept conveniently near for this purpose. A tightly corked bottle containing alcohol, and a couple of brushes of different sizes will be found on the worktable of all radio shops where work of the better sort is done.

In addition to its use for removing the excess of soldering flux, for the sake of appearance, alcohol is used to cleanse contacts and prevent corrosion.

Although most soldering fluxes do not cause any trouble in this respect, when used on heavy work, it will be found, after a time, that noticeable corrosion has set in, where one is soldering the hair-fine wires required in some equipment.

MORE STATIONS AND BETTER, CLEARER RECEPTION WITH THE CE-LEC-TOR
 A TRUTONE PRODUCT

THE ORIGINAL STATION SEPARATOR

The CE-LEC-TOR is a band pass filter with a new, novel and patent method of cutting off infringing side bands, being particularly effective on low wave lengths. It also balances the aerial and tunes the first tube.

The band pass features in the CE-LEC-TOR prevent more than one station being heard at one time. Another great feature of the CE-LEC-TOR is that it reduces static; there is nothing that will entirely eliminate it, but on actual tests the CE-LEC-TOR decreases noises attributed to "static."

EASY TO USE
 Absolutely no tools are necessary to attach the CE-LEC-TOR to any radio. It is only 3 1/2 in. high and 2 3/4 in. diameter. From it are two wires, one to attach to the binding post and the other to the aerial lead-in. Send for Folder. Manufactured and Guaranteed by TRUTONE RADIO SALES CO. 114-116 Worth St., New York

\$6.50

KILLS NOISES
 In All Electric Radios

SI-LEN-SER
 A TRUTONE PRODUCT

Eliminates Hum! Stops Interference

The SI-LEN-SER makes any electric or any electrified set play quietly and free from hum. It silences all stray power line noises which enter the receiver through the power packs of electric sets and eliminators. The SI-LEN-SER eliminates absolutely all hum from powerhouse generators, and all bothersome knocks and noises that emanate from such electrical sources as nearby power lines, such devices as electric refrigerators, vacuum cleaners, oil burners and other noise-breeding electric household apparatus.

At Your Dealer or Direct Upon Receipt of Price. Satisfaction or Your Money Back.

\$12.50

TRUTONE RADIO SALES CO.
 114-116 Worth St. New York, N. Y.

HARKNESS
 1929
SCREEN GRID DE LUXE

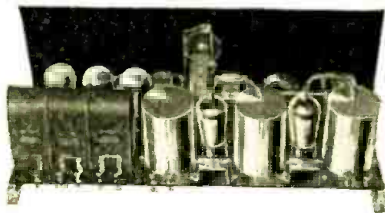

Get Distance Through Locals!

Haven't you always wanted a receiver which really GETS distant stations when you tune for them?

Of course, you want to get nearby stations with good tone quality and without interference. Almost any modern set will do that. But here's a receiver which not only gets all the locals with marvelous tone quality but which cuts right through interference and brings in far distant stations with loudspeaker volume.

As a distance-getter the new HARKNESS "Screen Grid de Luxe" has no equal in its

price class. It is GUARANTEED to be the most sensitive 5-tube set in existence.

In the Harkness Laboratory, New York, the "Screen Grid de Luxe" is on demonstration every day. Hundreds of local set-builders have visited this laboratory and listened to the reception of distant stations all over the country—while locals were going full blast. In one evening 37 distant stations were logged between 8 and 10 P. M. At another public demonstration, KFI, Los Angeles, was tuned in with loudspeaker volume. Cincinnati, Schenectady, Pittsburgh and Atlantic City have all been received in BROAD DAYLIGHT.

Enormous R.F. Gain

The remarkable distance-getting records of this receiver are made possible by the use of two screen grid tubes in a new and highly efficient circuit developed by Kenneth Harkness. The tremendous amplification of screen grid tubes is utilized to the fullest advantage. The weak signals of distant stations are magnified hundreds of times and reproduced with loudspeaker volume. The set reaches out and brings in stations from all over the continent, stations you could not possibly hear except with the most expensive super-heterodynes.

Perfect Selectivity

Even in congested districts like New York and Chicago you can cut through the locals and get distance every night. The sharp tuning is obtained by the use of special R.F. transformers designed for this set.

A.C. and Battery Models

To meet your local requirements, there are two models of the "Screen Grid de Luxe." The battery model is for use with A and B batteries or eliminators. The A.C. model uses A.C. tubes throughout.

Inexpensive—Easy to Build

With all its remarkable advantages the HARKNESS costs less to build than an ordinary 5-tube set. It is one of the lowest-priced kits on the market. You need little or no experience to build the set. Our complete kit contains all the parts required, including drilled front and sub-panels. Full-size blue prints, showing assembly and wiring, enclosed with each kit.

Tremendous AMPLIFICATION!

Amazing SELECTIVITY!

The Outstanding "SCREEN GRID" RECEIVER

of 1929

Complete Kit of Parts

LIST PRICE *
only \$59.90

Mail Coupon Below

Write your name and address on the coupon below and mail it today. We will send you our illustrated folder describing the "Screen Grid de Luxe" in more detail. Write us a letter or post-card—or use the coupon below.

KENNETH HARKNESS Inc.

Suite 305-A 72 Cortlandt St. New York City

MAIL THIS NOW

KENNETH HARKNESS Inc., Suite 305-A, 72 Cortlandt St., New York City.

You may send me your free illustrated folder describing the battery and A.C. models of the HARKNESS "Screen Grid de Luxe".

Check here if you are a dealer or professional set-builder and want us to quote you our wholesale prices.*

Name
 Full Address
 City State

*Unusually large discount from this price to dealers and professional set-builders. Check and mail coupon for details.

FREE! Mail coupon for literature and full details



Reclaiming Sulphated Storage Batteries

In instances where the plates of storage batteries are only discolored and not badly corroded or broken, this reclamation process will prove valuable.

By C. W. TECK

PERHAPS you have a storage battery lying about, unused since your last vacation time because, upon your return, you found it would not work. Perhaps your first step was to take the battery to a "battery expert" who, with an eye for business, promptly told you the battery was "sulphated." Also, he probably said the battery was of no further use; that, if the battery had been left in storage while you were away, the battery would not have sulphated.

While it is true that the battery characteristics would have changed little, had the battery been given proper attention, it is not quite true to state that the battery is "no good." The battery man, you suppose, knows his business. That is so, but there are times when a specialist can offer a solution which the average practitioner is not aware of.

In the first place, let us find out what has happened to our fairly new storage battery of reputable make.

The chemical lead that forms the active material of the plate or element, which had been formed by an electric current acting on the metallic lead in an electrolyte, had been reacted upon by this same liquid during its long period of rest.

Its chemical composition was lead oxide, which readily undergoes a change when the external circuit of the battery is closed and makes this type of battery unique for its usefulness, but now it has become an insoluble, crusty substance that, besides being inactive as a chemical

agent in the battery, actually stops the current from flowing by its high resistance and by the added fact that to do this the acid must be taken from the electrolyte, bringing the latter resistance away up. It is no wonder that the average battery man pronounces a battery "dead," after he has tried to send a current through the battery to charge it and finds he cannot.

There is not merely this resistance to consider, which easily enough could be broken down, but there must be a complete reversal of the process that had taken place while the battery lay idle. The lead sulphate must be reduced and the acid given back to the water, before there is formation of oxides in sufficient quantity to return a useful current.

The actual condition then is such that, as long as sulphuric acid has combined with the chemical lead of the plates, the battery is "dead," for all the practical value it has.

Reclaiming through persistent *charging* can be effective only if the "deadness" is very recent; when of long standing, it is almost impossible.

But, *there are chemicals which dissolve lead sulphate* and these may be placed in the cells *without harmful effect* to the battery.

The following method of reclaiming sulphated batteries will be found effective, even if the batteries have not been in use for years!

Reclaiming Method

The first step is to catch a gallon or two of rain water by placing an earthen

vessel in the open where no soot deposit will be washed into it. (This may sound like some alchemistic formula, but it is only an ordinarily convenient way of obtaining almost pure water.) After this is done, filter the water and store it away.

Two quarts of the water are used to dissolve one-half pound of chemically pure potassium hydrate. Potassium hydrate is most generally known as caustic potash. (Handle with care.)

The battery is then emptied out to rid it of any water or electrolyte, as the case may be. Then, pour in the solution of potassium hydroxide, until the tops of the plates are covered. Having done this, charge the battery in the usual way, though at a lower rate.

After 24 hours, discharge through a resistance and put again on charge for the same period. This second charge will, in all probability, have corrected the sulphated condition.

The battery should give a full six volt reading and maintain such a charge for a short while. However, no attempt should be made to discharge it. Or, if the experimenter wishes to work with the battery, it should be recharged again before putting in new acid solution.

To clean out the solution which has by this time become, for the most part, a salt solution (potassium sulphate), the batteries are emptied and refilled with rain water and allowed to stand for several hours. It may be to advantage to connect the battery to the charging

(Continued on page 45)

Servicing "A Whistling" Receiver

A SHORT time ago the question arose as to how a certain receiver could be made to operate more nearly like the present-day receivers of similar type. Although only two years "of age", it is now considered to be out of date.

The objectionable effects were R.F. oscillation and low signal volume.

The first step was to determine the electrical and mechanical conditions which existed. These were: A 5-tube radio frequency receiver using R.F.

transformers with 12-turn primaries and 96-turn secondaries. The antenna circuit was tuned, making a total of four tuned circuits and an unusually selective combination. A "potentiometer" and rheostat were the R.F. gain controls. Every stage was adequately shielded. Only one-half the potentiometer could be used before the circuit "spilled over". The "B" was adequately bypassed.

The trouble was diagnosed as being capacity-feedback effect due to the use of '01A tubes with R.F. transformers

having a high number of primary turns.

Screen grid tubes were decided upon, as these have low inter-element capacity and consequent low feedback. The only changes necessary were to increase the R.F. "B" potential to 135 volts, remove all wires from the "G" post of each socket and put them on the respective screen grid tube caps, wire each "G" post on these sockets to 45 volts positive, and insert a type '22 ballast in one side of each of the two negative filament leads, using the poten-

(Continued on page 46)

WHOLESALE PRICES

JUST OFF THE PRESS!

2ND EDITION

**F
R
E
E

F
R
E
E

F
R
E
E**



for Dealers, Community Set Builders, General Repairmen and Agents!

Our new, **HUGE, LARGER PAGE SIZE (8" x 10½")** WHOLESALE CATALOG No. 19, 2nd Edition, enjoys the enviable distinction of being universally accepted by the RADIO TRADE in the same manner that a school treasures the Dictionary and Encyclopedia Britannica—or the home the Bible and Almanac!!

The preparation and distribution of this **MAMMOTH** Catalog **COSTS A TREMENDOUS SUM**—the huge volume of business derived from it warrants this cost as well as the genuine pleasure it gives us to know that those "in the know" regard our catalog **AS THE OFFICIAL ORGAN OF THE 1929 RADIO SEASON!!!**

This **FREE CATALOG** is literally a most valuable **ENCYCLOPEDIA**—**YOU** cannot well afford to be without one—and, you do not have to. Your request for one is all that is needed! A day or two later, it is in your possession! Surely, a **TEST OF OUR PROMPTNESS PLEDGE!**

OUR CATALOG LISTS MORE Completely Assembled All-Electric A.C. Receivers

than any other Radio Catalog!
AVAILABLE IN CHASSIS FORM, OR MOUNTED IN TABLE OR CONSOLE CABINETS, WITH AND WITHOUT BUILT-IN LOUD SPEAKERS.
Our Rock-Bottom Net Prices for these sets will astound you!

Those having No. 18, or No. 19 (1st Edition) Catalog, should immediately send for No. 19, 2ND EDITION. ALL PRICES HAVE BEEN REDUCED TREMENDOUSLY!

Buy from Radio's Oldest Mail Order House!

In these many years we have been in the Radio Mail Order Business, we have learned from **EXPERIENCE** how such an organization must be efficiently run in order to **GAIN AND RETAIN THE GOOD WILL OF OUR CUSTOMERS**. In this, our **DETERMINED GOAL**, **RADIO SPECIALTY COMPANY OFFERS TO SHIP PRACTICALLY ALL ORDERS IN FROM 6 to 24 HOURS**—OFFERS YOU **100% QUALITY MERCHANDISE ON A STRICT MONEY-BACK BASIS IF NOT THOROUGHLY SATISFIED**—AND OFFERS YOU **ALL MERCHANDISE AT ABSOLUTE ROCK BOTTOM NET PRICES!** OUR CATALOGUE CONTAINS THE **LARGEST ASSORTMENT OF GENERAL RADIO MERCHANDISE IN THE COUNTRY**. Only the most successful manufacturers' products are listed—such lines as **PILOT—SILVER—MARSHALL—CARTER—AERO—YAXLEY—TOBE—HAMMARLUND—AMER—TRAN—CUNNINGHAM—DONGAN—THORDARSON—MUTER**, etc., etc. **THE LATEST IMPROVEMENTS IN RADIO ARE LISTED AND THOROUGHLY DESCRIBED IN THIS GREAT CATALOG:** A.C. ALL ELECTRIC Sets with self-contained ABC power supply—Public Address Amplifier systems—A.C. Set Converters—A and B Eliminators—Dynamic Speakers and Units—Magnetic Speaker Chasses—245 and 250 Tube Amplifiers—Airplane Cloth Speakers—Push-Pull Power Amplifiers—Electric Phonograph Turn-Tables—Combination Radio and Electric Phonograph Consoles—Speaker Tables—Short Wave

And, if we do not list in our catalog your Radio requirements, **WE WILL OBTAIN SUCH PARTS, BILLING YOU AT THE USUAL TRADE DISCOUNTS!**

"RASCO" has it

Radio Specialty Co.

Sets and Adapters—Shield Grid Tube Kits—Television Parts, Cameras—Workshops—and large assortment of Lathes, Electric Drills, Electric Saws, Electric Grinders, etc.—Violet Ray Machines, Electric Flatirons, Stoves, Percolators, Toasters, Fans, Washing Machines. **LOGICALLY HOW CAN YOU AFFORD TO BE WITHOUT OUR CATALOG—SEND FOR ONE NOW!**



98C PARK PLACE, NEW YORK



INFORMATION BUREAU

SPECIAL NOTICE

When writing to the Information Bureau, correspondents are requested to observe the following rules:

- (1) Ask as many questions as desired, but furnish sufficient information to permit a proper diagnosis. Carefully drawn schematic diagrams are often desirable.
- (2) Inquiries (not too involved) to be answered by mail must be accompanied by 25c in stamps, per single question. Blueprints are not available.
- (3) Use only one side of paper and LIST each question.
- (4) We cannot furnish comparisons between commercial instruments.

(The reader with the greatest number of interesting questions each month, although they may not all appear in the same issue, will find his name heading this department.)

Highest for the Month: JAYNE H. RILEY with 6 Interesting Questions

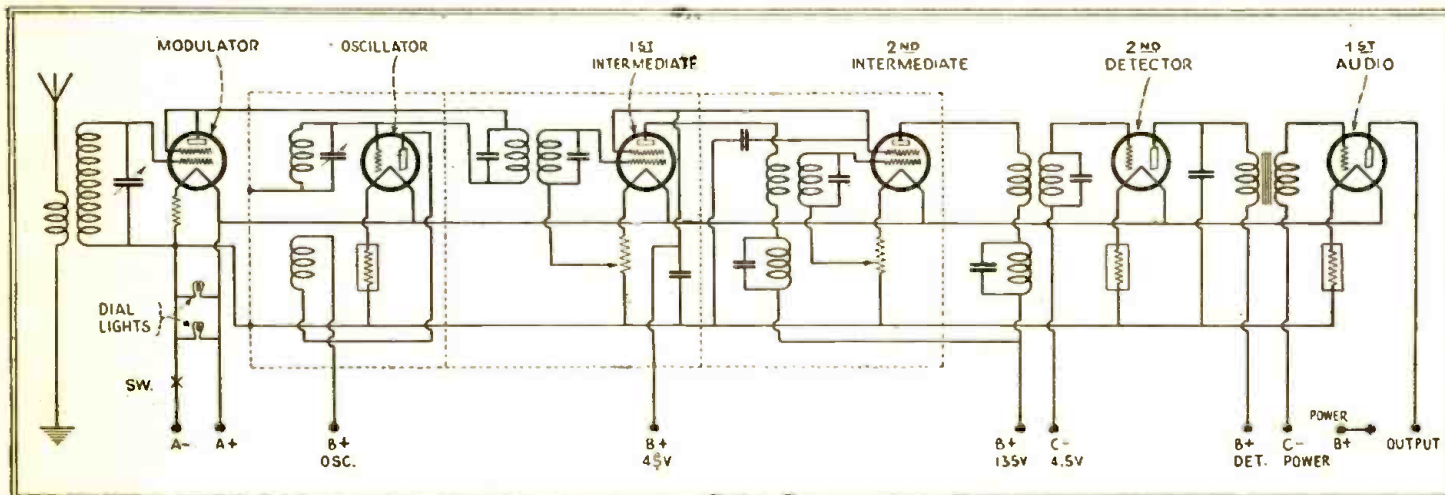

(Q. 1.) The Lacault R.E.29 (new Ultradyne) is shown in schematic form. One unique part of the design is the use of a four-element, screen grid tube as a special three-element "modulator". The "modulation" system about which have revolved all previous Ultradyne models, is retained in the new receiver; this circuit acting to supply a tube-generated A.C. to the plate of the mixing tube instead of a battery current, or D.C.

LACAULT, RE 29

(1) Mr. Myron Glantzer, Brooklyn, N. Y.
 (Q.) I understand that the late Mr. R. E. Lacault had developed a new Ultradyne. Has this circuit been made public? If so, what are the construction details?
 (A.) The last superheterodyne developed by Mr. Lacault is shown in circuit form in these columns.

Construction details, however, are complicated and constitute a lengthy article, the first portion of which appeared in the April 6th issue of *Radio World* magazine.

Due to the particular design of the intermediate frequency transformers which operate at a wavelength above the broadcast band (120 Kc.), selectivity is all that could be desired.

There is no undesirable oscillation, and volume control is obtained at the power pack designed for this set.

The first detector or "modulator" tube derives its plate potential from the oscillator. The voltage is A.C. instead of D.C. The plate and shield grid of the modulator tube connect together.

Shielding is used where desirable to restrict to desired programs the amplification of two of the three '22 type tubes and to confine the energy of the oscillator.

Plug-in inductances are a feature of the set, rendering it possible to tune to stations on different bands.

There is a total of six tubes.

DEFINITIONS—TUNING—SOLDERING

(2) Mr. Jayne H. Riley, Croton-on-the-Hudson, N. Y.

(Q.) What does "anti-mobo" mean?

(A.) It means anti-motor boating, the peculiar throbbing sound caused by circuit oscillation at sub-audio frequencies. This expression will probably come into very general use in America, as we continue to develop amplifiers reproducing the very lowest notes.

(Q.) What is "zero beat" tuning?

(A.) With an oscillator or oscillating detector circuit, it means tuning exactly to the center of a station's carrier (wave). Adjusting the tuning dial a hair's breadth left or right will start a howl, heard in the reproducer first as a growl and then, as the dial motion is continued, as a note rising in intensity and pitch to a powerful shriek, in most cases, going finally beyond the limits of hearing. The sketch illustrates this in exaggerated form.

(Q.) I want to solder a flat piece of glass to a sheet of metal. How can I do it?

(A.) We do not know of any way of "soldering" glass to anything, using the usual tools which consist of solder and a flux, with the contact made directly between the two materials. However, by an intermediate step, by *plating the glass*, one can actually solder glass to metals. Perhaps it will be more exact to say one can solder metal to metal, one metal being a tight film on the glass. Details of this method appear in the April issue of the *Scientific American*.

OSCILLATION—222'S—REPRODUCER CONDENSERS

(3) Mr. Alan K. Wright, Warrenville, N. J.

(Q.) How can I stop whistles, lack of sensitivity and tuning that is too sharp? I never had these troubles before.

(A.) You do not state whether your set is of the battery or battery eliminator "B" supply type.

Presuming the former:

1. Your "B" battery supply probably should be renewed; or,
2. The "A" may be low.
3. In the latter event you may need a new rectifier tube.
4. In either case the "C" battery may need to be changed.
5. The set may have an open grid lead in one of the circuits; in the detector circuit, this would probably test as a defective grid leak.
6. The antenna or ground may not be in good condition.

(Q.) Is the cap on a shield grid tube connected to the shield grid?

(A.) No. It is connected to the control grid. The shield grid connects to the tube prong connecting with the "G" or grid post of the tube socket.

(Q.) Is there any advantage in placing one condenser on each side of a speaker, instead of only one condenser in the circuit, to insulate the speaker from the supply?

(A.) No. It is connected to the control grid. The shield grid connects to the tube prong connecting with the "G" or grid post of the tube socket.

(Q.) Is there any advantage in placing one condenser on each side of a speaker, instead of only one condenser in the circuit, to insulate the speaker from the supply?

(A.) There are several advantages to the idea.

Sets operating on D.C. lighting lines usually require insulation from the ground; placing the reproducer on grounded metal might cause a short circuit. Also, there is the danger of getting a shock if the reproducer and certain parts of the set were touched at the same time. This would apply to any type of set.

Then again the single condenser might become leaky or break down altogether, unless of the best and more expensive type. The heavy "B" current shunted through the reproducer would probably burn out the windings.

WIRING—SHORT WAVES—SHOCKS

(4) Mr. Orion Bland, New York City.

(Q.) Can a radio set be built without the use of a soldering iron? It seems to me every set made is soldered.

(A.) If instruments are used which have binding posts or provision for screws, there will be no difficulty in making a set that way. However, the contacts will eventually loosen and the set will become almost unaccountably noisy due to these "microphonic" contacts.

The trouble is due not so much to poor work at the start as it is to expansion and contraction of the materials, as weather conditions change; eventual slight corrosion causes the microphonic noises. The proper use of lock washers will help greatly to keep the connections tight.

(Q.) What is the advantage of short waves; I get all the broadcast programs I want on the regular wavelengths?

(A.) Not everyone is as fortunately situated as you are—many are quite distant from broadcast stations; or, have locations that are poor for reception.

The short waves also carry over astounding distances and the thrill one may receive from time to time as distant calls are heard, is an

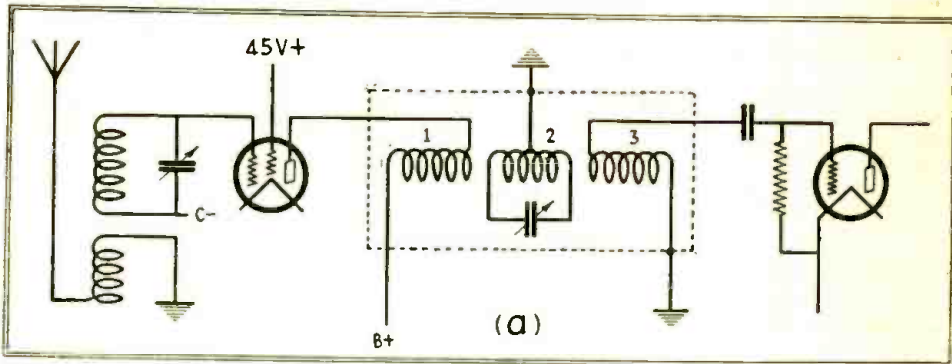

(Q. 6.) In this circuit suggestion, a "center-tapped wave trap" is used to couple two untuned circuits. This should make an excellent receiver, if properly adapted.

the interest in short waves but these are not of moment to the average broadcast listener.

(Q.) I have a D.C. "mains" set well insulated by antenna and ground series condensers. Why is it that I get a shock when the shield cans and radiator are touched at the same time?

(A.) Evidently the shielding of your set is grounded to the set wiring, which is connected to the lighting lines, and contact with it and the ground (radiator) completes the lighting lines circuit to ground, through your body.

Have grounded everything in sight, including condenser rotors and the dials.

(A.) Probably high ground lead resistance.

1. Ground lead may be too long.
2. Ground wire may have high resistance or be open.

3. Earth to which grounding conductors lead may be dry.

4. Defective ground clamp.

5. Open at the set "ground" binding post.

6. If house piping is used, this may have several high resistance joints. (In considerable gas or electric piping, "insulating couplings" are used.)

SAFETY CONDENSERS—SHORT WAVES—CAPACITY EFFECT

(5) Mr. K. L. Reardon, New London, Ct.

(Q.) What size condenser do you recommend for insulating aerial and ground against causing D.C. line fuses to blow?

RECEIVER DESIGN—CIRCUITS—S. W. "SUPERS"

(6) Mr. J. F. Gutzmer, Chicago, Ill.

(Q.) I would like to be able to match up coils and condensers for various receivers. The

(Q. 2.) "Zero beat" tuning is represented in this drawing. While it is interesting and often necessary (when receiving continuous wave signals) to operate the detector just beyond the regeneration point, there is the disadvantage of radiation. However, a single stage of radio frequency amplification is usually sufficient to reduce this to a negligible quantity.

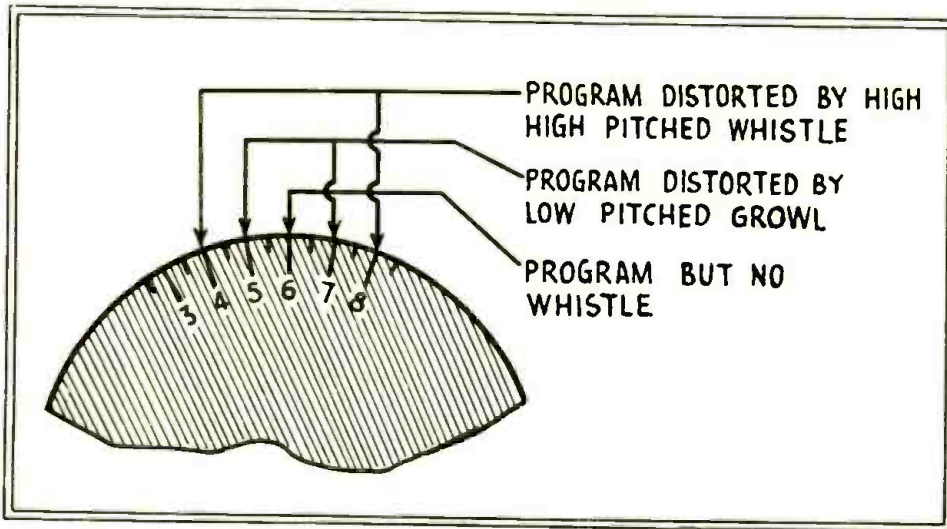

Many people prefer the quality of reception obtainable with an "oscillating detector," although it is usually found that low notes are not clearly reproduced. (Theoretically, the high notes should not reproduce well.) Oscillation of radio frequency circuits at resonance is often a quick and convenient means of checking the "tracking" of tuning controls.

appeal to thousands. In many districts static during certain months makes clear reception of broadcast stations on the regular wavelengths almost an impossibility. Short wave receivers, on the other hand, will often receive these broadcasts with practically no static disturbance.

There are a great many other reasons for

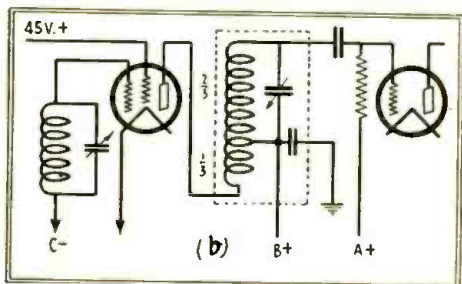

(Q. 6.) One form of auto-transformer adapted to receiver construction. The shield must not approach the coil closely.

(A.) About 0.1 mfd. will be quite large enough. We recommend that the "operating voltage" rating be at least 250 volts and preferably higher.

(Q.) I have a short wave receiver, the circuit of which will not oscillate at any point, on five coils ranging from 20 to 200 meters. How can this be remedied?

(A.) You do not enclose your circuit, so we can give you only a general answer. Granting the circuit is correct, check off the following points:

1. Defective tube.
2. Shorted antenna coupling condenser (antenna coupling too close).
3. Defective detector plate circuit choke.
4. Low "A" or "B" potentials.
5. Reversed tickler leads.
6. Defective R.F. coil secondary (or primary).
7. Leaky tuning condenser insulation.
8. Corroded connections.

(Q.) I cannot seem to eliminate "hand capacity" effect in another receiver I have. I can tune stations in and out by moving my hands in relation to the tuning dials (metal).

necessity of buying certain manufactured coils has often prevented me from trying out many circuits.

(A.) We believe the information you request is contained in an article by Mr. Berry, which will appear in the August issue.

(Q.) I would like to experiment with some different ideas in circuit design. Will you please suggest a few?

(A.) In these columns will be found three skeleton circuits of unusual type. It is recommended that screen grid tubes be used.

In circuit (a), the best values for coils 1, 2 and 3, are to be determined by experiment. Coil No. 2 is tapped at the centre of its turns, the number of which depend upon the variable condenser value. Coils 1 and 2 should be quite compact and will have perhaps in No. 1 coil, one-half the number of turns in No. 2 coil; the third coil may have twice the number of turns in the second coil.

Coils 1 and 2 are arranged to slide in varying inductive relation to coil 3.

Circuit (b) is more obvious. Probably a 2:1 turns ratio will be about right. The two

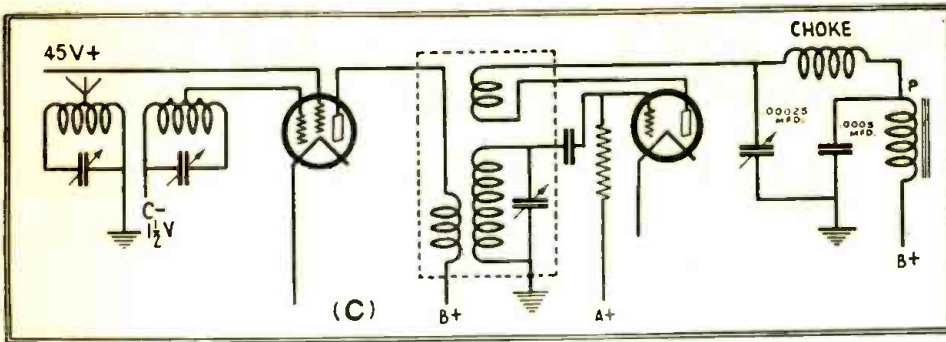

(Q. 6.) In this circuit arrangement, the control element of the screen grid tube may tap to either of the other points indicated on the diagram. The result is a 3-dial-controlled receiver with great possibilities. Selectivity is mainly determined by the coupling of the antenna coil to the screen grid input coil.

portions may be slidably arranged to vary the inductive relations.

In circuit (c), the construction is obvious. It must be remembered to keep all coils small; not over one and one-half inches in diameter and of a proportionate length. A diameter of one inch and a length/diameter ratio of 2:1, is popular now. This means it will be necessary to use small size wire.

The shielding cans should not be placed too close to the coils. An end clearance (at one end) of three inches and a side clearance of one and one-half inches will be satisfactory.

You will probably find combinations using the ideas shown, which result in unusually good distance reception.

(Q.) Please let me know whether it is practical to construct a superheterodyne for reception of music and code signals on the short waves.

(A.) Such an arrangement as you suggest has proven quite practical. We will shortly publish an interesting article covering the constructional details for this type of receiver.

'22s—TONE—"TONE COLOR"

(7) Mr. J. C. Wharton, Wharton, N. J.

(Q.) Is the screen grid tube practical?

(A.) Absolutely. Individual tubes vary and only the best makes should be purchased. If

possible, at least hear the tubes operating in a set before purchasing.

(Q.) Is it possible to get power tube quality without using power tubes?

(A.) The primary purpose of power tubes is to develop considerable amounts of undistorted power. Vacuum tubes with special characteristics are the most satisfactory solution. Amplifiers using batteries and special microphones have been built but are too noisy to be practical.

(Q.) What is "tone color" control?

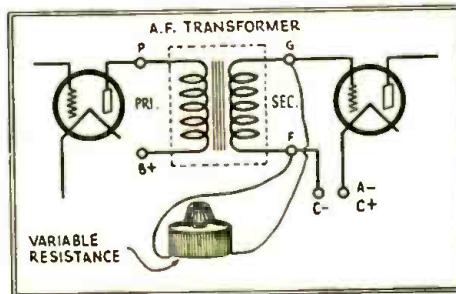

(Q. 7.) Any set owner who has not yet tried this experiment has an interesting experience before him.

(A.) This loosely applied expression means a control of the reproduction quality and volume. Some people associate certain colors with certain notes and that is probably the origin of the term. A simple so-called "tone control" is a variable resistance (see illustration) in shunt with the secondary of the first audio frequency transformer.

GRID LEAK—ANTENNA COUPLING—RESISTANCE

(8) Mr. L. I. Adams, Boston, Mass.

(Q.) Is the grid leak value on short waves the same for broadcast waves?

(A.) Usually, higher for the short wavelengths; one or two megohms for 200 meters and up, and two to eight, below.

(Q.) Varying the antenna coil coupling throws off the tuning dial readings considerably, which makes logging difficult. How can this be prevented?

(A.) It cannot easily be prevented. The simplest way to overcome this greatly is to:

1. Use a very compact antenna coil in relation to the filament end of the tuned circuit.
2. Grounding the filaments may help.
3. Antenna and grid coils should be wound in the same direction.
4. Antenna end of primary and grid end of secondary should be at the extremes of separation.

(Q.) I would like to use an ordinary battery carbon as a resistance. What is the average value of one which is six inches long?

(A.) About 55 ohms. It varies about five ohms each way.

SPEECH AMPLIFIER

(9) Mr. Kenneth Wandell, Lansing, Mich.

(Q.) Please print, in the questions and answers columns of *Radio-Craft*, the schematic circuit of the new Silver-Marshall No. 690 speech amplifier which can deliver 15 watts of undistorted power.

(A.) The circuit you request appears in these columns.

Push-pull stages balance out A.C. hum. The 0.3 meg. units are stabilizing resistances used to prevent oscillation of the push-pull power circuit.

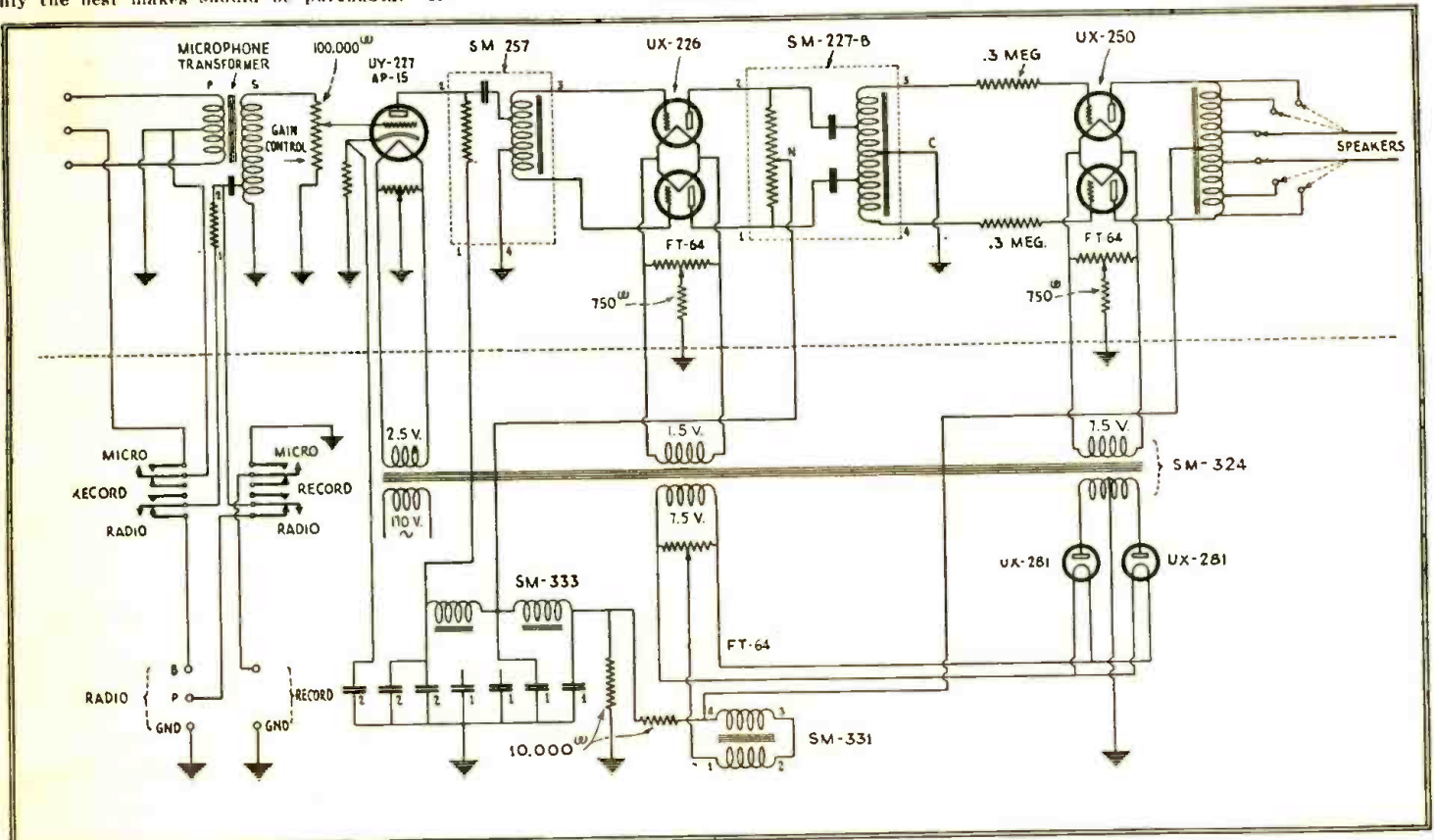

(Q. 9.) Schematic circuit of the Silver-Marshall No. 690 Speech Amplifier. This circuit can be recommended as very efficient and as having tone quality difficult to surpass. The method of obtaining a balanced signal input to the first two tubes in push-pull is of unusual interest.

Variometer Type I. F. Transformers

By R. Wm. Tanner, W8AD

RECENTLY a set of I.F. transformers were needed, for an experimental superheterodyne, which could be peaked at some wave just above the broadcast band. These could have been constructed very easily if a semi-variable condenser for each transformer had been available. As such was not the case, other means had to be resorted to.

Regenerative receivers of a few years ago employed a variable inductance or variometer to tune the grid circuit.

It was thought that this principle could be applied to tune the grid circuits of the amplifier in a superheterodyne. Unlike the old type variometer, the inductance range would not have to be great, therefore the separation between rotor and stator would be of little consequence.

Silver-Marshall type 130P midget coil forms are ideal for I. F. transformer windings. They may be plugged into five prong UY tube sockets making a neat appearing as well as efficient unit. As a number of these were at hand, the writer decided to use them in preference to any other form.

The primary is wound in the slot at the bottom of the form and consists of 55 turns (for '01A tube or 140 turns for the '22). The wire should be as small as is possible to handle without breaking. No. 36 enamel proved to be about right. The start of the winding is soldered to the F2 prong and the finish to the P prong.

The secondary is started just above the slot and wound in the same direction as the primary. This has 213 turns of No. 28 double cotton covered wire in three layers. If the builder cares to and has an abundance of patience, a three bank winding will probably be more efficient, however the layer wound secondary serves the purpose very nicely.

The rotor is merely a coil of small diameter placed within the form on a 1/8" wooden spindle. This is in two sections of 100 turns of No. 28 each. The winding form is 1/2" in diameter. First one section is scramble wound, then removed from the form and tied in two or three places with string. Then the other section is wound and tied in the same manner. The spindle is cut so that it fits tightly in the form and the two coils tied to this, one section on each side. When completed, the rotor is placed near the top end of the secondary and one of the leads soldered to the finish of the secondary. The other lead goes to the G prong.

The start of the secondary winding is connected to the F1 prong, with the C prong left open.

When placing the coil sockets into circuit, P goes to the plate, G to the grid, F1 to the filament and F2 to the "B" positive.

In lining up an amplifier employing this type of transformer, tune in a fairly weak signal and with a pencil, vary the position of the rotors in respect to the secondaries for maximum volume. The minimum to maximum range is obtained by a variation of 180 degrees of the rotor.

Now FORGET AERIAL TROUBLES!

Get New Selectivity and Clarity on Both Local and Distant Stations

Delightful Freedom from Interference—Sweeter Tone



Why go on listening to terrible static and other maddening outside noises? Now, with this marvelous new Radio Invention, Subwave-Aerial, Radios can get reception—music, singing, speaking—just as clear and sweet toned as if the players were right in the room with you. Reach out and bring in DX Stations crisp and clear that were smothered out by power-line noise and strong Local Station interference without the use of Subwave-Aerial. The air is always full of static and your overhead aerial picks it up and brings it to your speaker. So why stay in the air—when you can get earth-purified ground wave reception with the use of Subwave-Aerial? Reports from Tests and Users prove that a new joy in Radio reception awaits you.

PROOF!

After investigating and making tests with your underground antenna. I find that the results obtained are very satisfactory.

I would recommend it in place of loop aerials, inside aerials or roof aerials because I find we are able to obtain clearer reception, also it reduces outside interference and static, and gives better selectivity. It is easy and convenient for the user to install.

HARRY R. JACKSON,
Radio Engineer.

Simple, Convenient

You've no idea how easy it is to install Subwave-Aerial. Takes only about 5 minutes—and you never need to worry about keeping it in order. Old Mother Earth takes care of that! She keeps wind, storms, lightning, power-line noises, rust, corrosion, soot and other roof-aerial evils away—and provides actual scientific protection by "short-circuiting" the electrostatic capacity of the buried aerial. Costs no more than an overhead or loop aerial and less than many. NO UPKEEP COST. Subwave-Aerial is permanent. No trouble—no hard work, or risking your neck on roofs.

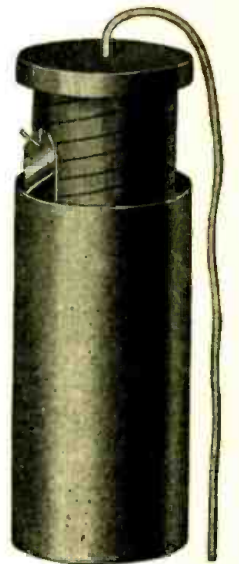

Subwave-Aerial Guaranteed for 25 Years

Any Subwave-Aerial which has been installed according to directions and proves defective or deteriorates within 25 years will be replaced free of charge; also we will pay \$1.00 for installing any such new replacement.

Try Subwave-Aerial FREE

Now you have a chance to prove the merits of this great new radio development for yourself. Try to pick a night when static is bad and make the thrilling test. It's fun. Be sure to send today for the interesting details on Subwave-Aerial and our Free Test Offer.

Underground Aerial Products

Suite 618, St. Clair Bldg.
Dept. 831-K.W.
St. Clair & Erie Sts. Chicago, Ill.

UNDERGROUND AERIAL PRODUCTS,
Suite 618, St. Clair Bldg.,
Dept. 831-K.W.,
St. Clair & Erie Sts., Chicago, Ill.

Rush illustrated literature on the new Subwave-Aerial and details of your Free Test Offer.

Name

Address

City..... State.....

Subwave-Aerial

PATENTS TRADE-MARKS

Don't Lose Your Rights To Patent Protection

Before disclosing your invention to anyone send for blank form "EVIDENCE OF CONCEPTION" to be signed and witnessed.

LANCASTER & ALLWINE
475 Ouray Bldg., Washington, D. C.
Originators of forms "Evidence of Conception"

Travel On "Uncle Sam's" Pay Roll

\$158 to \$225
MONTH
Men—Boys
18 up

FRANKLIN INSTITUTE
Dept. T-256, Rochester, N. Y.

Rush to me free information telling how I can get into the U. S. Gov't service as Railway Postal Clerk or City Mail Carrier or Post Office Clerk. Send list of positions now obtainable.

Mail Coupon Immediately

Name

Address

Air Wonder Stories

AIR WONDER STORIES which will be out on all newsstands on June 10th, is a fitting sister magazine to SCIENCE WONDER STORIES. It is a revelation in science fiction stories of the air. Be sure to reserve a copy now or make yourself sure of it by subscribing.



Big Magazine
Size 9 x 12"
4 Color
Cover

The Copy
25c

On All
Newsstands

Thirty years ago one of the greatest scientists and mathematicians PROVED mathematically that flying in a heavier-than-air machine was impossible. Will he dare say now what the limitations of aviation will be? It has long been known that the possibilities of today are tomorrow's facts.

AIR WONDER STORIES has been created to explore the path of aviation and see whither it is bound. Progress in any line of endeavor is impossible unless we can project ourselves into the future.

AIR WONDER STORIES contains only fiction of the mechanical-scientific-technical kind designed to stimulate the reader, and incidentally, the inventor. Nothing like it has ever been published before.

**Special Subscription Price
8 Issues \$1.00**

STELLAR PUBLISHING CORPORATION
Dept. RC7, 96-98 Park Place
New York, N. Y.

Enclosed find \$1.00 for which enter my subscription for 8 (eight) months to your monthly magazine, "Air Wonder Stories".

Name

Address

City and State

Science Wonder Stories

DRAMATIZED MECHANICS

Stories with a
Scientific
Background

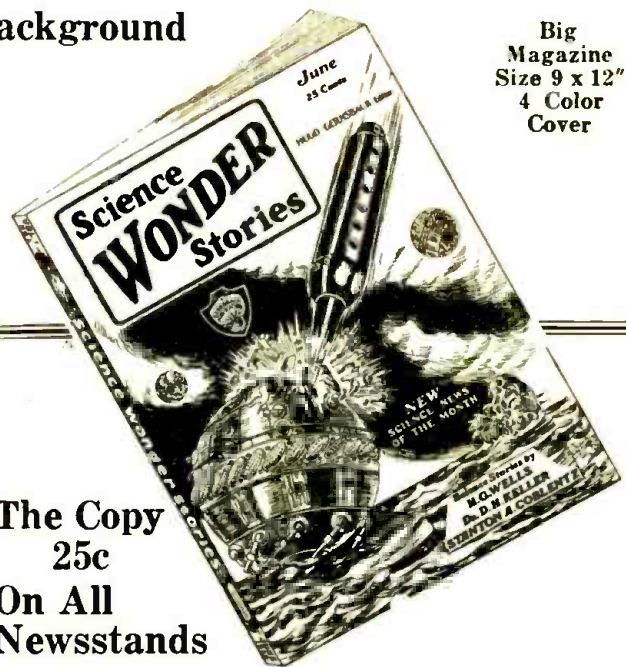

Big Magazine
Size 9 x 12"
4 Color
Cover

The Copy
25c

On All
Newsstands

HUGO GERNSBACK, *Editor-in-Chief*

DAVID LASSER, *Literary Editor*

FRANK R. PAUL, *Art Director*

ASSOCIATE SCIENCE EDITORS:

ASTRONOMY

Professor Samuel G. Barton
Flower Observatory, University
of Pennsylvania
Dr. Clyde Fisher, Ph.D., LL.D.
Curator, The American Museum
of Natural History

ASTROPHYSICS

Donald H. Menzel, Ph.D.
Lick Observatory, University of
California

BOTANY

Professor Elmer G. Campbell
Transylvania College
Professor Margaret Clay Ferguson, Ph.D.
Wellesley College
Professor C. E. Owens
Oregon Agricultural College

ELECTRICITY

Professor F. E. Austin
Formerly of Dartmouth College

ENTOMOLOGY

William M. Wheeler, Dean,
Bussey Institution in Biology,
Harvard University

MATHEMATICS

Professor C. Irwin Palmer
Dean of Students
Armour Institute of Technology
Professor James Byrnie Shaw
University of Illinois
Professor Waldo A. Titsworth, S.M.
Alfred University

MEDICINE

Dr. David H. Keller
Western State Hospital

PHYSICS AND RADIO

Dr. Lee deForest, Ph.D., D.Sc.

PHYSICS

Professor A. L. Fitch
University of Maine

ZOOLOGY

Dr. Joseph G. Yoshioka
Illinois State Institute for Juvenile Research

**Special Subscription Price
8 Issues \$1.00**

STELLAR PUBLISHING CORPORATION
Dept. RC7, 96-98 Park Place
New York, N. Y.

Enclosed find \$1.00 for which enter my subscription for 8 (eight) months to your monthly magazine, "Science Wonder Stories".

Name

Address

City and State

Everyone Can Understand Television
By Reading

**ABC of TELEVISION
or SEEING by RADIO**

"Yesterday's Dream Today's
Reality"

By **RAYMOND FRANCIS YATES**
Editor of "Television"

100 Engravings and Half-Tone
Photographs. 250 (6x9) Pages
Price \$3.00

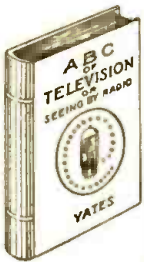

The practical introduction of TELEVISION into the realm of everyday things is of far greater importance than was the development of sound by radio. The development of TELEVISION in the immediate future will be none the less amazing, and even more marvelous.

Now is the time for those who wish to follow the progress of this new miracle of science and engineering, to grasp and firmly fix in the mind its engrossing fundamentals. To grow with a new art is easy; to catch up with an old one requires perseverance and tenacity.

The "A B C OF TELEVISION" is not a book for "engineering high-brows" nor is it a superficially prepared volume written to amaze and entertain the novice. Rather, it is an intensely practical volume written for the practical amateur who wants to "do things" in television or for the serious student who would keep abreast of the times. The "A B C OF TELEVISION" stresses the "how" of the art rather than the "why," although sufficient space has been devoted to underlying physical and electrical laws to satisfy the most critical.

The book is, in its essence, an academic treatise brought down to the level of the lay mind. Engaging in its simplicity, penetrating and wide in its scope, it stands as the first popular American book devoted to television and telephotography.

The "A B C OF TELEVISION" comprises 250 profusely illustrated pages. The first portion throws the soft light of understanding on the subject of different television systems in use today. In so doing, it clearly, concisely, and in the simplest of terms, outlines the real fundamentals of each system. The problems of scanning, amplification of light modulated signals, photo-electric and selenium cells, neon lamps and synchronizing appurtenances are covered in detail.

The book has been written essentially for those who wish to build television receivers and transmitters either for entertainment or research purposes.

TABLE OF CONTENTS

- Introduction
- 1—Television—The New Conquest of Space
- 2—Television Systems
- 3—Telegraphing Pictures
- 4—Photo-electric Cells—Eyes of Television
- 5—Amplifying Pictures
- 6—The Agile Neon Lamp
- 7—Selenium Cells
- 8—The Problem of Scanning
- 9—Synchronizing Television
- 10—Transmitting Television at Home
- 11—How to Make a Television Receiver

**TECHNI-CRAFT
PUBLISHING CORP.**

98 Park Place, New York City

"SUPREME" AMPLIFIER

(Continued from Page 8)

the hum of the average A.C. type speaker was greater than that of the amplifier.

The power transformer, heavy duty choke and filament heating transformer are mounted on the left side of the sub-panel as are also the rectifier tubes.

The voltage divider and condenser block are mounted directly in back of the A.C. voltmeter and if the case of the condenser pack is grounded it forms a shield between the power equipment and the audio channel proper.

The 250's (or 350's) in push-pull are in the back center and the '26 push-pull intermediate stage to the right, forming a symmetrical and efficient layout for the push-pull stages.

The sockets and transformers for the '27 type tubes are lined up with the push-pull intermediate stage as well as the audioformer first stage isolating choke.

Two 30-henry chokes which are used as plate circuit isolators for the push-pull stages are mounted on the front center of the sub-panel.

The front panel is fastened to the sub-panel with machine screws which bolt to the three brass brackets, details of which are shown in drawing.

The fixed resistors and associated bypass condensers are mounted under the sub-base.

Provision is made to furnish "B" voltages for a radio set, if so desired, by means of the binding posts located at the rear center of the sub-panel.

The front panel is of bakelite as well as the base panel although a metal base panel can be employed, thus saving wiring. It would be advisable to ground all of the transformer and choke cases, being careful that the windings or condensers do not short circuit to their respective cases.

Assembly

Having obtained the material as specified and tested all equipment for open circuits or shorts with a battery and meter we are ready to lay out and drill the panel and chassis.

The proper placing and drilling dimensions can be readily obtained from the large size drawings of the panel and sub-panel. Holes must be drilled for the various leads to the sockets and transformers as all of the wiring should be done on the under side of the sub-panel if possible.

Wire the sub-panel first; it is suggested that the various filament lines be wired at the start. Connect the filament circuit of the '50's and the filament circuits of the '81 rectifiers leaving leads long enough to reach the switch on the front panel and the A.C. voltmeter.

The entire job can be more quickly finished by leaving the front panel off and having enough length to the sub-panel wires to reach the panel instruments after the former has been wired.

The 1.5-volt filament connections should now be made to the two '26's in the intermediate push-pull stage.

With the completion of the filament circuits accomplished by the connection

**SHORT-WAVE
FANS**

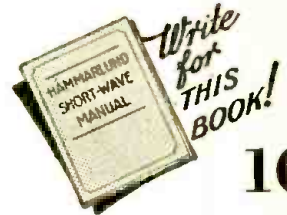

THE greatest radio advancement in the immediate future will probably be in the field of short waves.

Whether you are interested in short-wave transmission, reception or in Television which uses short-waves, the Hammarlund Short-Wave Manual will help you solve many technical problems.

HAMMARLUND MFG. CO., Dept. R.C. 7
424-438 W. 33rd St., New York, N. Y.

Enclosed find 10 cents for Short-Wave Manual.

Name

Address

HAMMARLUND MFG. CO.,
424-438 W. 33rd St., New York



**SUPER-POWER
AMPLIFIER**

**JACK GRAND
IS HERE!!!
WRITE HIM ABOUT HIS
SUPREME POWER AMPLIFIER
AS DESCRIBED IN THIS ISSUE**

**NOW
at lowest prices!**

Complete parts, as specified by Jack Grand for his Supreme Power Amplifier, always in stock.

Write for our special prices on complete kit or separate parts as needed.

FULL DISCOUNTS
To Dealers and Set
Builders

COMPLETE BLUEPRINTS
Full Size \$1.00
Free with Kit

List Price
205¹⁵/₁₀₀

SUN RADIO CO.
64 VESEY ST. N.Y.

new Scott A.C. SHIELD GRID 10



E.H. Scott

~exceeds World Record Performance of all preceding models

The World's Record for distant reception—117 programs in 91 days, all 6,000 to 8,000 miles away—established and still held by Scott Receivers is destined to be outdone by the new Scott A. C. Shield Grid 10. For this great new laboratory-built receiver employs four stages of maximum gain shield grid intermediate amplification and an audio system embracing a stage of 245 push-pull. It is therefore capable of far greater amplification than its record-making predecessor.

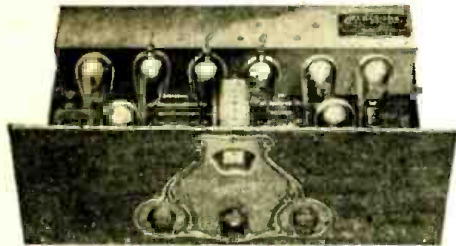

And it has one-dial, one-spot tuning! Think of it! Only one dial to tune and no station comes in at more than one point on the dial! Actual 10 kilocycle selectivity, too, and reproductive quality such as can be obtained *only* thru precision methods in force in the Scott Laboratories.

MAIL COUPON

for DEMONSTRATION Offer!

No matter what your present concept of radio perfection may be, it will be delightfully exceeded when you turn the dial of the new Scott World's Record Shield Grid A. C. 10. Mail coupon for Special Demonstration offer. Clip and mail coupon at once.

SCOTT TRANSFORMER CO., Dept. 10
4450 Ravenswood Avenue • CHICAGO, ILL.

SCOTT TRANSFORMER CO., Dept. 10
4450 Ravenswood Ave., Chicago, Ill.

Send me full particulars of the new Scott models of World Record Radio. Also your Special Demonstration Offer.

Name.....

Address.....

City..... State.....

**HEAR ALL STATIONS
CLEAR AS A BELL
TUNES YOUR AERIAL**



THE POWERTONE TUNER

will help you get greater distance, greater volume, greater selectivity, less static, less interference and better tone quality.

Price \$1.00

POWERTONE ELECTRIC CO.

222 Fulton St. New York, N. Y.

of the 2.5-volt winding to the two '27 type tube sockets, start wiring the "C" bias resistors to their proper by-pass condensers and center tap resistors. These resistors should be tested and the wiring checked carefully so that when the unit is placed into operation the proper bias will be obtained and possible damage to tubes and transformers avoided.

Wire the input leads to the first tube and A.F. transformer, leaving long leads to connect to the front panel switch controls.

Now, wire the grid leads of all the A.F. transformers to their respective sockets and then complete the sub-panel by connecting the plate leads of the above-mentioned transformers and sockets.

Run the various "B" voltage supply lines to their respective chokes, jacks and by-pass condensers and then to their respective terminals on the transformers.

Now we are ready to fasten the front panel to the sub-panel with nickel plated machine screws. Complete the wiring of the amplifier by connecting the various wires coming up from the sub-panel to their respective connections on the panel.

Turn all bias resistor controls so that the maximum resistance is in each circuit. Insert the two '81 rectifiers in their sockets. The '50's, '26's and the two '27's are now properly placed and the amplifier is ready for test.

Connect a phonograph pick-up or radio set to the proper input terminals and place unit in operation.

Adjust all "B" voltages with a high resistance voltmeter so that the proper voltages are obtained, as shown in drawing.

The bias resistors are now adjusted so that the correct operating current is supplied as specified by the tube manufacturer for the voltage applied; this is checked up on the 0-150 milliammeter. The amplifier is now ready for service.

Electrad D8 can be used in "Max. Voltage" lead if voltage is too high for the '50 type tubes.

List of Material

- 1—Thordarson Type T2950 Power Transformer
- 1—Thordarson Type T3100 Double Choke
- 1—Thordarson Type R300 Audio Transformer
- 1—Thordarson Type T2922 Push-Pull Input Transformer
- 1—Thordarson Type T2973 Intermediate Push-Pull Transformer
- 1—Thordarson Type T2903 Out-Put Transformer for Dynamic Spkr.
- 1—Thordarson Type R190 High Impedance Choke
- 2—Thordarson Type 196 Filter Chokes
- 1—Flechtheim 250 Block Type DX25 Condenser Block
- 2—Flechtheim 2 Mfd. Type B200 200-volt Bypass Condenser
- 2—Flechtheim 1 Mfd. Type B100 200-Volt Bypass Condenser
- 1—Flechtheim 4 Mfd. Type HX400 650-Volt Bypass Condenser
- 1—Flechtheim .1-1 Mfd. Type F20 Buffer Condenser
- 5—Carter No. 2A Jacks
- 1—Carter No. 32A Jack Switch
- 1—Carter No. 66 Jack Switch
- 2—Carter No. 10 Tip Jacks
- 2—Carter Phone Tips
- 1—Carter Tu-way Phone Plug
- 2—Electrad Type B Fixed Resistor, 50,000 Ohms
- 1—Electrad Type T Truvolt Resistor, 1,000 Ohms
- 1—Electrad Type T Truvolt Resistor, 3,000 Ohms
- 1—Electrad Type T Truvolt Resistor, 1,500 Ohms
- 1—Electrad Type D Fixed Resistor, D 410-S
- 1—Electrad D-8 800 Ohm Resistance (Optional)
- 2—Electrad Type V Center Tapped Resistors, 20 Ohms
- 1—Bakelite Sub-panel, 12 x 27 x ¼ inch
- 1—Bakelite Panel 9 x 28 x ¼ inch
- 10—Eby Binding Posts
- 6—Benjamin Standard 4 Prong Sockets
- 2—Benjamin Standard 5 Prong Sockets
- 1—Jewell O-10 A.C. Voltmeter
- 1—Jewell O-150 Milliammeter

BECOME A CHARTER SUBSCRIBER TO

RADIO-CRAFT

and save 50% of the subscription price.

Send \$1.25 in check, money order or stamps, and we will enter your subscription for one year (12 issues). (In Canada, \$1.50.)

TECHNI-CRAFT PUBLISHING CORP., 96-98 Park Pl., N. Y. C.

BOOK REVIEW

Radio Receiving Tubes. By James A. Moyer and John V. Wostrel, published by McGraw-Hill Book Co., Inc., New York; 5" x 7 1/2", 298 pages, 181 illustrations, 8 tables, cloth cover. Price \$2.50.

This very handy-size book presents the radio tube situation from a wide angle perspective. The book cannot be classed as expensive and it should interest many radio students and practitioners, even though we find the inclusion of considerable material not in keeping with the title of the volume.

For example, there is the chapter, "Fundamental Electrical Relations" (dealing in part with Ohm's Law by water analogy), 31 pages in length.

Also, there is a "Table of Symbols" which includes indicia for the plug fuse, the ammeter shunt, the electric arc, and four forms of spark gap. Many modern symbols, including that of the shield grid tube described in the text, are not shown.

The 80-odd pages of the chapter, "Industrial Applications of Vacuum Tubes," hold little of interest to the man best able to use the technical "meat" of the book.

Most of the information is rather closely linked with associated mathematics. This makes the first reading a bit laborious, as the average reader will not care to check the formulas and is compelled to mentally separate one from the other to read only the text.

About two-thirds of the book contains, in convenient size, information on tube theory and operation which the practical and theoretical radio technician will want to consult from time to time.

NOTICE

This being a summer issue, it is of necessity smaller in volume than subsequent numbers will be.

Beginning with the next issue, the size of RADIO-CRAFT will be increased a great deal.

Enjoy Dependable Electrified Radio at Amazing Low Cost!



Do you know that your present good set is capable of giving you quiet, dependable, more enjoyable reception direct from the light socket? Don't think of discarding it when you can electrify it for only \$6.85!

New Radio Thrills!

No need now to put up with the shrieks, howls and inconvenience of dying Batteries. You will see how easily you can electrify your set when you write us for proof and the truth about all-electric radio. Get more volume without hum, sweeter tone, crystal clarity, surprising distance. New radio pleasure.

Over 100,000 Townsend "B" Power Units Now in Use

Hooked up in a few minutes—use same tubes—no changes. Over 100,000 Townsend "B" Power Units in use and giving satisfaction. Approved and passed by the rigid laboratory tests of Radio News, Popular Radio and other authorities.

TRY IT FREE We are so sure the Townsend will do all we claim for it that we give you the privilege of testing it out for ten days at our risk. A new radio joy awaits you. Don't put up with second rate reception any longer. You don't have to—when you can have electric reception with a Townsend "B" Power Unit for the astounding low cost of \$6.85. Mail coupon for complete information TODAY!

TOWNSEND LABORATORIES
723 Townsend Street Chicago, Ill.

\$6 ONLY 85 COMPLETE

RESULTS

Have had wonderful reception with your "B" Eliminator on my AT-WATER KENT for two years now. C. E. Smith, Snyder, N. Y.

Am entirely satisfied with Eliminator purchased from you last summer. Am getting many Florida stations we did not get before. Geo. Cadman, Hamilton, Ont.

Your Eliminator has given us perfect service for over a year on our STEWART-WARNER model 300. Fred S. Kattelman, Glendale, Calif.

Your Eliminator very satisfactory. Has saved me the price of buying a new set. Have had it almost a year and it performs as well as any \$35 Eliminator. Fred Kosanovic, Fairchance, Pa.

TOWNSEND LABORATORIES. 8/29
723 Townsend St., Chicago, Ill.
Please send me full information on the Townsend "B" Power and Free Trial Offer.

Name

Address

City..... State.....

BECOME A CHARTER SUBSCRIBER TO RADIO-CRAFT

and save 50% of the subscription price.

Send \$1.25 in check, money order or stamps, and we will enter your subscription for one year (12 issues). (In Canada, \$1.50.)

TECHNI-CRAFT PUBLISHING CORP. 96-98 Park Place, N. Y. C.

S. GERNSBACK'S RADIO ENCYCLOPEDIA
THE FIRST RADIO ENCYCLOPEDIA EVER PUBLISHED



Size 9 x 12" 549 Illus.

168 Pages 1930 Definitions

SPECIAL PRICE \$1.49

Edited by **SIDNEY GERNSBACK**, Author of "Wireless Course in Twenty Lessons"—"One Thousand and One Formulas"—"Practical Electricity Course"—"The Radio Educator," etc.

S. GERNSBACK'S RADIO ENCYCLOPEDIA is the only standard work ever published in America attempting to classify alphabetically the countless

words used in the highly specialized science of RADIO. The ENCYCLOPEDIA is written in plain English so that everybody can understand the definitions and descriptions.

No expense has been spared, covering over two years in compilation, to make it worthy a place in your library.

It is published in one volume—168 pages—size 9 x 12 inches, nearly an inch thick and nicely accommodates the beautiful illustrations and the large, easy to read type.

The work contains 1,930 definitions, 549 photographs, drawings and diagrams.

REMEMBER THIS IS A REAL ENCYCLOPEDIA—NOT A DICTIONARY—and very few of the things described and illustrated in this volume can be found in any dictionary, or any other encyclopedia.

The book contains as a supplement a classified cross index designed to bring together radio references under one heading having relations in common.

All circuits new and old are described by word and picture and every part and apparatus used in Radio is explained and made understandable by means of photographs and drawings.

The volume is printed upon fine paper—bound in full black Keratol, marbled paper fly leaves and end sheets, with the title stamped in gold.

SEND NO MONEY

Just forward the Coupon below and the Encyclopedia will be sent you at once. You pay the Postman \$1.49 plus postage on delivery and if the book is not satisfactory return it and your money will be paid back at once without any questions.

ISKOR PRESS, Inc.
286 Fifth Ave., New York

ISKOR PRESS, Inc.,
286 Fifth Avenue,
New York.

Send me one copy of Sidney Gernsback's First Radio Encyclopedia in one volume as advertised. I will pay postman \$1.49 plus postage on delivery.

NAME

ADDRESS

TOWN and STATE.....

RADIO MEN — who know values — use FLECHTHEIM Superior Condensers and Voltmeters

Save Money and Get the Finest Results

FLECHTHEIM SUPERIOR PRODUCTS

Are of the Best Quality Workmanship Highest Grade of Materials and are More Reasonably Priced. Demand Them and Obtain Fullest Satisfaction.

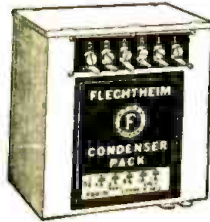

Type F14-171 Pack List Price \$11.00

Type CV-600-O-600 A.C. & D.C. List price \$12.50

Service Men, Custom Set Builders, Dealers, Jobbers—Write for Catalogs

A. M. FLECHTHEIM & CO., Inc., 136 Liberty St., N. Y. C.
Dept. 1 RC

THE A. C. SCREEN GRID "SEVEN SEAS" CONSOLE

(Continued from Page 21)

coil has a low impedance. A matching transformer with a high impedance primary to match the output tube transformer secondary (which has a high impedance), and a low impedance secondary to match the low impedance voice-coil of the reproducer, is usually a part of dynamic speakers.

However, the ensemble design makes it convenient to use an output tube transformer with a low resistance secondary which matches the low impedance voice-coil. Of course, eliminating one transformer results in improved tone quality. An "A.C." type of dynamic reproducer is used. The "A.C." part is purely a bow to those to whom anything not operating by means of batteries, is "A.C." Actually, this dynamic speaker field is energized by the total rectified current output of the power pack. It is interesting to note that this pulsating D.C. supply obtains its filtering through the use of only one choke coil. However, this choke coil has an unusually large inductance, as it constitutes the field winding of the dynamic reproducer. In addition, the two filtering condensers are of unusually large capacity, each one having a capacity of eight microfarads. They are not electrolytic, but nevertheless are of the "self-healing" type.

Push-pull circuits will oscillate readily, unless all conditions are balanced. It has been found difficult to build push-pull amplifiers which would operate consistently under the varying conditions imposed in various localities, due to the variations existent in tubes. Where laboratory facilities are available, this is of no moment, but the average set user does not have these facilities at his command. By shunting one-half of the input push-pull audio frequency transformer with a capacity, as shown, the possibility of circuit oscillation, which results in high current drain, short amplifier tube life, short rectifier tube life, and distorted reception, is practically eliminated.

The console selected for this receiver is figured and lacquered. The doors slide, instead of swing. The rear of the cabinet is mesh-covered for heat radiation purposes and also for acoustic efficiency in connection with the reproducer included in the console.

WAVE LENGTH/FREQUENCY TABLE

Meters	Frequency	Meters	Frequency
1	300,000Kc.	85	3,529Kc.
2	150,000	90	3,333
3	100,000	95	3,158
4	75,000	100	3,000
5	60,000	105	2,857
6	50,000	110	2,727
7	42,860	115	2,609
8	37,500	120	2,500
9	33,333	125	2,400
10	30,000	130	2,308
15	20,000	135	2,222
20	15,000	140	2,144
25	12,000	145	2,069
30	10,000	150	2,000
35	8,571	155	1,935
40	7,500	160	1,875
45	6,667	165	1,818
50	6,000	170	1,765
55	5,454	175	1,714
60	5,000	180	1,667
65	4,615	185	1,622
70	4,286	190	1,579
75	4,000	195	1,538
80	3,750	200	1,500



The Very Meter You Want Most!

Take Your Choice of 9 Instruments!

YOU finish building a set or power pack. You want to test it for voltage and current. You need some particular meter to make the test complete. Always the necessity for that meter, like recurring hunger! What wouldn't you give to have that meter here, NOW! No more need to endure such irritating deprivation. You are hereby given your choice of any one of nine different meters free! Please use the coupon.

CHOOSE ONE OF THESE NINE METERS!

- 0-6 Voltmeter D.C. No. 326
- 0-10 Amperes D.C. No. 338
- 0-100 Milliamp. D.C. No. 390
- 0-50 Voltmeter D.C. No. 337
- 0-25 Milliamp. D.C. No. 325
- 0-300 Milliamp. D.C. No. 399
- 6-Vt Chge Tester D.C. No. 23
- 0-50 Milliamp. D.C. No. 350
- 0-400 Milliamp. D.C. No. 394

Put a cross in the square next to the meter you desire, and fill out and return coupon below. All meters except No. 23 are panel mount types; size of hole, 2 5/64"

WHAT RADIO COMPANIONSHIP DO YOU ENJOY?

ARE you meeting weekly the best minds of radio? Do you keep abreast of all the new circuits, the intimate details on perfecting existing sets, and get the inside track on sensitivity, distance reception, tonal quality, and how to achieve them? Do you keep fully abreast of the news of radio, technical and non-technical? If not, here is your chance to enjoy the writings of Dr. Lee De Forest, McMurdo Silver, J. E. Anderson, Herman Bernard and a host of other radio engineers who contribute their knowledge to you through the medium of Radio World, the first and only illustrated national radio weekly (eighth year!)

You will find Radio World specializes in most intimate revelations of the ins and outs of the best circuits, with technical accuracy second to none. Enjoy the weekly companionship of Radio World's famous contributors, and glean the news of radio, from the four quarters of the earth.

Short waves? Radio World will tell you all about them. Extremely sensitive broadcast receivers? Their construction and operation are fully discussed with confident regularity. Power supplies—push-pull or otherwise? AC receivers? Screen grid tubes? Large receivers that give a super-abundance of performance—small, economical receivers that give performance out of all comparison to their size? Automatic volume controls? Band-pass filters? New tubes? Are you interested in these? Then you're interested in Radio World. Send \$1 now for 8 weeks subscription, one copy a week (regularly \$1.20) and meter you select will be sent FREE!

RADIO WORLD, 145 W. 45th St., N. Y. C.
Published Weekly—All Newsstands—15c copy—\$1.50, 3 months—\$3, 6 months—\$6 a year.

RADIO WORLD
145 West 45th Street, New York City
(Just East of Broadway)

Enclosed please find \$1 for which send me Radio World for eight weeks (one copy each week), and also send me FREE, at once, the one meter checked below.

- No. 326
- No. 337
- No. 23
- No. 338
- No. 325
- No. 350
- No. 390
- No. 399
- No. 394

Name

Street Address

City State.....

5-DAY MONEY-BACK GUARANTEE

SERVICE MAN'S DATA

(Continued from page 34)

board; it can be left charging over night.

The latter operation is of great importance, since some of the alkali may remain in a particular cell and would give a wrong specific gravity reading when the battery is charged normally.

When all this has been done, the regular electrolytic solution is put in, and the battery charged again in the usual manner. It will be as good as it ever was.

Monitoring the Loud Speaker

By Charles Golenpaul *

Few radio sets there are, whether home-made, custom-built or manufactured, that cannot be improved by controlling or *monitoring* the loud-speaker both for volume and for tone. Obviously, circumstances of reception vary all the way from the loud crash of dance music to accompany shuffling feet and happy voices, to the subdued musical background for the dinner conversation or bridge game, as regards volume, and from the crisp, sparkling band music to the soft, mellow, soothing slumber hour melodies.

Fortunately, there are two simple elements involved in monitoring the loud-speaker for volume and tone. The first element is resistance, which controls the current flow and therefore the response of the loud-speaker. The second element is capacity, which serves to by-pass more or less of the higher frequencies which would otherwise pass through the loud-speaker and introduce more or less of the sharpness and sparkle desirable in some selections but quite undesirable in others.

In either event, the control or monitoring means must be conveniently at hand, so as to be readily adjusted by the listener-in. While the volume control incorporated in the radio set itself may be satisfactory in many instances, for the dyed-in-the-wool radio fan the control should be remotely located, so as to be adjusted from davenport, easy chair, dining-room table and so on. For this purpose a variable resistance with a long extension cord is required. If the house is wired for radio, so as to place a loud-speaker in any room, the monitoring may be done right at the loud-speaker.

For the control of the volume, the simplest method is to place a table type variable high resistance in series with the loud-speaker. This is relatively simple in the case of the external or separate loud-speaker. However, in the case of the built-in loud-speaker in the usual self-contained radio set of today, the table type 0—500,000 ohm resistance may be shunted across the loud-speaker terminals or again across the output of the amplifier. In many cases the variable resistance may be shunted across antenna and ground terminals of the set.

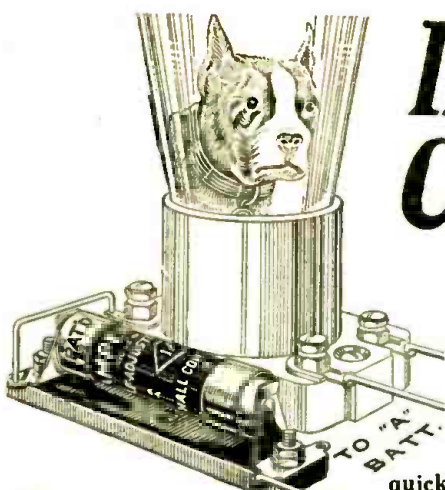

"AMPERITE"
Watch Dog
of Your
Tubes

**If TUBES
Could Talk!**

They would tell you—that only at the prescribed filament temperature, can their tonal qualities, clarity and sensitiveness be brought out to the full. That "A" current constantly varies according to the state of the battery or load on the house-current line—and that operation with too little or too great current is certain death to efficient tube performance—and too quickly, of the tube itself. That only **AMPERITE** can automatically control this exact current despite variation in the supply—as long as sufficient current is to be had. That you should never confuse **AMPERITE** with fixed filament resistors which do not do **Amperite's** job. **AMPERITE** is sold by dealers everywhere. A type for every tube, A.C. or D.C. \$1.10 mounted (in U. S. A.).

Write for FREE "Amperite Blue Book" of the season's best circuits and latest construction data. Address Dept. R.C.T.

Radiall Company

50 Franklin St., New York

AMPERITE

REG. U.S. PAT. OFF.

The "SELF-ADJUSTING" Rheostat

DETECTOR BOOSTER

BOOST RECEPTION 10 TIMES with this two-tube super detector unit! It adds pep to your set—brings in stations you never heard before—and makes weak stations roar in with amazing volume.

Simply plug it in your detector socket, and it gives an additional stage of audio amplification. For battery type sets. Fully guaranteed. Write today for further information or mail your order.

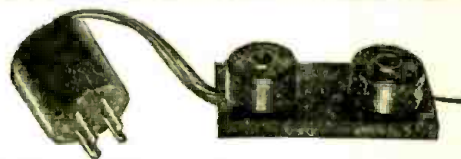

Price \$3.25—Use Coupon Below

**FITCH
SIMPLEX DYNAMIC SPEAKER**

For 6V. D.C. \$20.00
For 110V. A.C. \$30.00

IN CHASSIS FORM ONLY. AS ILLUSTRATED.

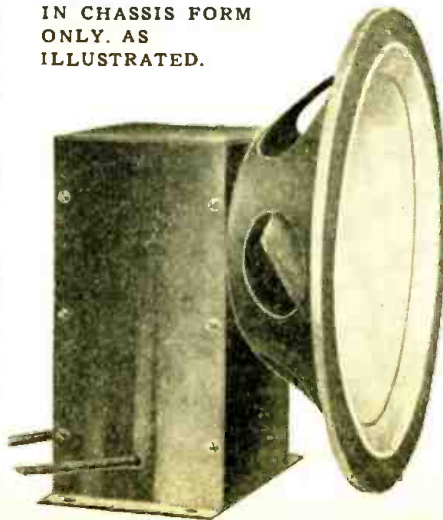

For those who want real dynamic quality, this **SIMPLEX** speaker CANNOT be equaled.

Ready to install in your console, or cabinet, or mounted on a baffle board, it gives tone reality that will astound you. For operation with or without power amplification.

Write for literature, or mail your order today. Pay postman when he delivers it, and try it on your own set. If not satisfied, return it within ten days and your money will be refunded.

C. J. FITCH, Inc.

72 Cortlandt St. New York

C. J. FITCH, Inc.,
72 Cortlandt St.,
New York, N. Y.

Gentlemen: Please send me the following on your 10 day money back guarantee:

Name

Address

*Engineering Dept., Clarostat Mfg. Co.

The most complete, comprehensive and authoritative RADIO HANDBOOK ever published!



Practical Radio Telegraphy and Telephony

By Rudolph L. Duncan

Director, Radio Institute of America

And Charles E. Drew

Instructor in Radio, and in charge of Electrical Division, Radio Institute of America

This book contains over 900 pages of practical information for SHIP, SHORE and BROADCAST OPERATORS, RADIO ENGINEERS, and AMATEURS. It is an ideal "Wireless Operators' Handbook" and a complete text for STUDENTS of Wireless Communication.

26 chapters—a progressive record of the latest 1929 practice—make this Radio Handbook indispensable for the practical radio man. Principles, methods and equipment are described in language readily understood by both expert and novice, and illustrated profusely with more than 460 clear and illuminating diagrams and photographs.

The authors are two of the foremost teachers of the subject in the country. The book is the product of the School Division of the Radio Corporation of America and therefore represents the last word on the subject.

Never before has such a wealth of practical and usable data been collected in book form for the use of the many thousands for whom Radio is the most fascinating subject in the world.

Price \$7.50

A WILEY BOOK

Send in this coupon at once . . . and examine the book at our expense.

FREE EXAMINATION COUPON

JOHN WILEY AND SONS, Inc.,
440 Fourth Ave., New York.

Gentlemen: Kindly send me on ten days' free examination, Duncan and Drew's "Radio Telegraphy and Telephony."

I agree to remit the price (\$7.50) of the book, within ten days after its receipt or return it postpaid.

Name

Address

Position or Reference.....

Yes, Subscriber No

RC-7-29

Whatever the arrangement followed, the volume of the loud-speaker may be readily adjusted so as to have the radio program fit in with the circumstances and desires.

As for tone control, there are two methods confronting us. The first calls for five mica condensers of .001, .005, .01, .015, and .02 mfd. capacity, arranged with a switch so that any value may be introduced into the circuit. This is rather costly and the mellowness is adjusted in steps rather than gradually. The second and simplest method depends on resistance to control the by-passing effect. In this case a ¼ mfd. condenser in series with a 0—500,000 ohm variable resistance is shunted across the loud-speaker terminals. As the resistance is lowered, more and more of the higher frequencies are by-passed, thus lowering the apparent tone of the loud-speaker and creating an effect comparable with that of the soft pedal on the piano.

It is impossible to exaggerate the pleasure derived from controlled or monitored radio reception. At one's finger tips the rendition may be adjusted for any degree of loudness and mellowness, with one control for volume and the other for tone. The handy radio fan can mount the controls on a small board or box, with a long extension cord, so that the radio can be instantly adjusted for background effect at times, and for maximum attention at others.

MODERNIZING A RADIO SET

(Continued from Page 34)

tiometer to obtain the correct control grid bias.

The results obtained were truly astonishing.

This "modernizing" idea may be applied to any receiver which has sufficient selectivity and a relatively large number of primary turns; the "neutrodynes" are one type of receiver with such a coil construction. When the screen tube is used, the neutralizing devices are removed. It is essential that each stage be shielded, even though special circuits have been developed in which the screen grid tube is used without stage shielding.

How to Improve Gaseous Rectifier Operation

By D. E. Replogle

Ever since the Raytheon gaseous rectifier tube was first placed on the market in 1925, there has been a great deal of research work carried on in the Raytheon Laboratories at Cambridge, Mass., not only aimed at improvements in the tube itself, but also in the associated circuits. As a result, new circuit changes have been developed, which are of considerable importance.

The first of the circuit improvements deals with the use of the buffer condensers. The function of these devices is to absorb any periodic disturbance that might be set up by the break-down of the gas in the rectifier tube itself. In the original gaseous rectifier circuit developed by these laboratories, two high-

voltage 0.1 mfd. condensers, connected across the transformer secondaries, are employed for this purpose. It has been found, however, that by employing two .02 mfd. condensers between the two anodes and the single cathode terminals, it is possible to obtain superior performance. This improved performance with smaller capacities results from the placing of the condensers at a more advantageous place in the circuit, namely, as close as possible to the electrodes of the tube, within which the disturbance is set up, and also by the operation of the buffer condensers at a higher voltage than when in their former location.

However, the greatest gain in the new B-power circuit † is in the matter of the filter choke coils. In the customary type of filter chokes, a large air gap is provided so as to prevent D. C. saturation. As a result, it is necessary to employ a large amount of both copper and iron in order to obtain sufficient inductance. The engineers, however, have found it possible to place the two choke coils on the same core, so that their D. C. flux cancels out and thus prevents core saturation without the use of an air gap. As a result of this flux-bucking choke, a saving of from 15 to 25 per cent is obtained, without decreasing the effectiveness of the chokes. A further though somewhat incidental advantage of the single-core construction, other than saving in labor and material, is the elimination of the necessity for shielding or careful placing of the chokes, relative to each other.

The performance of the B-power circuit can be still further improved by "tuning" the filter circuit for minimum ripple, which is accomplished by so varying the values of the capacities with relation to the choke coils, that the maximum hum suppression is obtained.

† The details of the improved B-power circuit are described at length in Technical Bulletin Vol. 1, No. 4, and will be sent to anyone addressing the Raytheon Manufacturing Company, Cambridge, Mass.

AGENTS WANTED

Free Book. Start little Mail Order business. Hadwil. 27A-74 Cortland Street, N. Y.

Orders - Inquiries

60 pages
Send for
FREE Copy

Can be
Secured
by
MAIL

POLK'S REFERENCE BOOK and Mailing List Catalog

Gives counts and prices on over 8,000 different lines of business. No matter what your business, in this book you will find the number of your prospective customers listed. Valuable information showing how to use the mails to secure orders and inquiries for your products or services is given.

Write for **FREE** Copy
R. L. POLK & CO., Detroit, Mich.
Largest City Directory Publishers in the World. Branches in Principal Cities. Mailing List Compilers—Business Statistics Producers of Direct Mail Advertising

AERO SHORT-WAVE RECEIVER

GERMANY
FRANCE
HOLLAND
ENGLAND
AUSTRALIA
COSTA RICA
JAVA
NEW-ZEALAND

REACHES AROUND THE WORLD



Short Wave Converter
Factory-Built, Ready to Plug Into Your Present Radio Set

Illustration shows the new Aero 1929 Converter—a compact factory-built short-wave adapter equipped with special short-wave coils. It is designed for both A.C. and D.C. Sets. Operates perfectly on all sets without motorboating, by an auxiliary filter system control, an exclusive feature (patent applied for). It can be plugged into any regular radio set. This amazing radio instrument now makes it possible for you to reach 'round the world—England, France, Germany, Holland, Australia, Panama, Spain, Java and many foreign stations are some that are tuned regularly on short wave. Permits you to enjoy international programs and many others from coast-to-coast that your regular receiver cannot get. What a thrill it is to plug this into a tube socket on your regular set and instantly be in another world! No change or wiring required. All complete, ready to operate, tubes and coils hidden, no apparatus in sight, except the neat, golden-brown, compact metal cabinet in crackle finish. Size 9x5½x2½ in.

The only converter we know of that really works on all sets. Two models—A.C. and D.C. Order from your dealer now, or remit \$25.00 direct, giving dealer's name. Free booklet on request. Dealers and Jobbers write for literature and prices.

Model A, for A.C. sets.....\$25.00
Model D, for D.C. sets.....\$25.00

AERO SHORT WAVE KITS

The world is at your instant call with Aero Short-Wave Receivers and Transmitters. The thrill of getting the far-off places of the earth, expeditions, ships at sea, transcontinental airplane messages and hearing musical programs and code messages from foreign countries is something you will enjoy tremendously. It's something new, something different. You can get this with an Aero Short-Wave Receiver. Astound yourself and your friends. These amazing hidden sides of radio reception are unknown to many, but thousands of fans are getting a bigger "kick" out of radio by their use.

You don't know radio until you get a taste of real short-wave reception with an Aero Standard or International Receiver. Try it yourself—you'll be happily surprised. Order an Aero kit today and you'll have a new interest and a new lease on life.

NEW 1929 AERO COILS

Since January 1st, 1929, many short-wave enthusiasts and "hams" have had difficulty in getting anywhere with their old sets. Aero was first to come out with new receiver and transmitter coils to meet the new conditions. The new 1929 Aero coil kits are now ready. Bring your old sets up to date. Get these new coils now and get everything that's in the air. The new Aero Listening Monitor is another 1929 product that is a necessity with "hams."

Send for the new 1929 supplement and the Big Green Book. Don't miss out on these newest developments.



4611 E. Ravenswood Chicago, U. S. A.



AERO Users Tune In on the World

List of foreign short-wave stations received by Richard H. Addison, 29 Armandine St., Boston 24, Mass., from October 1st to December 12th, 1928, using Aero Short Wave Coils:

6SW—Chelmsford, England; 5XX—Danvers, England; PCJJ—Eindhoven, Holland; PCLL—Kootwijk, Holland; CIRR—Whitney, Manitoba, Canada; 2ME—Sydney, Australia; 3LO—Melbourne, Australia; ANH—Bandeng, Java; 9R11—Heridea, Costa Rica; 1YB—Auckland, New Zealand, etc.

England, France, Germany, Holland and Australia!

List of foreign stations received by G. E. Morcroft, Jr., Bellevue, Pa., on set using Aero Coils:

6SW—England; PCLL and PCJJ—Holland; AFK—Germany; FW—Paris, France; ANH and ANE—Java; GBS—English Trans-Atlantic phone; 2ME—Sydney, Australia; 3LO—Melbourne, and 5CL—Adelaide, Australia, etc.

Gets South America and Honolulu

Under very unfavorable conditions, I have heard phone stations as far away as South America. Buenos Aires comes in great. I have had no trouble at all in getting KGU at Honolulu and P.W.X., Cuba. ALTHUR W. HOWARD, Boulder, Colo.

Gets Europe and South America

I desire to inform you that I have completed the Aero Short Wave Receiver and I am very well pleased with the results. I have already received European stations and South American stations, and practically every district in the United States, including Canada.
F. W. JACOBY, Cashier.

6,000 Mile Musical Reception

All of the receivers that I have built using your coils have been receiving musical programs from Eindhoven, Holland, on 30.2 meters and several times with loud speaker volume at four o'clock p. m., eastern standard time. I suppose that this reception distance is about 6,000 miles.

CHARLES WIGGINS,
Ancon, Canal Zone, Panama.

Aero Coils Are the "Berries"

Last night I got up about 2 a. m. and before the sun rose I logged 22 sixes, 5 BZ's, 2 F's, 3 A's, 2 Z's and several others whose call I mixed up or lost. All of these signals were on the 40 band and all were at least R4-5.

I really think your coils are the berries and all the boys that have seen the set are crazy about it.

Vy 73a es Cu agn.
2 AXJ (Bob Poucel, Op.)

England Every Afternoon

We have received your International Converter and we are well pleased with it. We get England every afternoon between 5 and 6 with a lot of volume.

MATHIS & BARKER.

Aero Coils on Byrd Expedition

Aero coils and parts are used in the short wave apparatus used by Commander Byrd on his Anarctic expedition.

Hears "Big Ben" Strike in London

Have heard, so far, 5 SW at Chelmsford, England, on 24 meters on March 21, 22 and 23, between six and seven o'clock E. S. T. I positively heard "Big Ben" striking twelve o'clock G. M. T. on these three nights.

HARRY MAYS.

Aero Products, Inc.,
4611 E. Ravenswood Ave., Dept. 2579, Chicago.
Send me one of your new 1929 "Aero-Call" Short Wave Converter Boxes, ready to plug into my set. Enclosed is remittance for \$25.00.

Your Name.....
Street and Number.....
City..... State.....
State whether A.C. or D.C. Model is desired.....
Name and Address of Dealer or Jobber.....

Barawik - the Old Reliable

RADIO SERVICE

A Special Service to Radio-Craft Readers

RADIO fans and readers, from "way back when," will remember the exceptional service that BARAWIK rendered when getting radio parts was like pulling hen's teeth. First upon the scene, BARAWIK was always ready to deliver the newest developments in radio to its customers in the days when chances were fast and furious.

Today BARAWIK has grown to be a mighty institution in the radio world. Here you can secure the proved, reliable merchandise of the world's leading radio manufacturers—everything from complete sets to the smallest individual parts so necessary to the set builder. You can depend upon the reliability of BARAWIK goods. You can depend upon BARAWIK'S ability to deliver the kind of service that means time saved in waiting. You can depend upon BARAWIK'S honesty, ability and willingness to serve you—and last, but far from least, you know that BARAWIK'S big discounts assure you of the lowest prices always—prices that mean huge savings to you in everything you buy.

In addition to a full line of the best known radio parts, kits and sets, BARAWIK offers to you a complete line of everything in the radio field—sets, radio furniture, tubes, power units, portable receivers, dynamic and other speakers, parts and kits for all popular circuits, short wave and television supplies, short wave transmitters, radiophones, public address systems, novelties, etc., as advertised in Radio-Craft and other radio publications.

BARAWIK also sells, at lowest money-saving prices, to customers the world over, auto tires and tubes, auto accessories, electrical goods, lighting fixtures, wiring material, household appliances, stoves, vacuum cleaners, washing machines, camping equipment, sporting goods, golf and baseball supplies, outing clothing and thousands of the things you and everyone else needs the year 'round for home, office, work and recreation.

Our central location insures fast service to customers in all parts of the country.

Radio-Craft readers will find in the BARAWIK Radio Catalog and Guide thousands of choicest bargains—the very things you need and use in everyday life. If you haven't a copy of this big Cyclopedic, send for it at once. It is free—mail the handy coupon below, while it is before you. Send today—now!

Television and Short Wave Equipment

Television is still in its infancy and far from perfect, but we are keeping abreast of all events in this new field and will be able to supply fans with the various necessary parts to keep up experiments as new developments come out. Note short-wave equipment listed to the right.

Radio Supplies

The BARAWIK CO. has, all these years, been famous for its variety of radio supplies, which it offers at money-saving prices. Newest dynamic speakers, "B" eliminators, socket power equipment, A-C harness, fine cabinets and furniture, amplifiers, latest short-wave and ham equipment, tubes, television supplies, batteries; in fact, anything you can ask for is here, ready to ship, at a saving in price. Quality merchandise, selected goods by reliable makers—just what you want—at big discounts.

Radio Kits

For those fans who want to "build their own," from first-class, reliable parts, we have complete kits of parts for every known circuit. The famous kits of the world's leading radio circuit designers—everything in the good old reliable stand-by circuits, as well as the new pretentious ones that are the last word in radio perfection. Hundreds of thousands of fans have used our kits and saved thousands of dollars. Your savings now are greater than ever.

Radio Parts

The standard parts of all the famous radio manufacturers are here for you to choose from. Your favorite part can be

had from BARAWIK at a bargain. Coils, transformers, condensers—audions, tone filters, panels, rheostats, switches, grid leaks, binding posts, brackets, wiring material, jacks, sockets, dials—everything you can think of—the best, newest and most famous brands—at big savings.

Radio Sets

BARAWIK factory-built sets are exceptional values. The newest and latest models from which to choose: battery-operated, all-electric, A-C, etc., with 5, 6, 7, 8, 9 and 10 tubes. In cabinets, self-speakers, consoles, highboys and many beautiful designs. Marvelous values in portable sets—great bargains in standard sets for home use. A variety of styles for every purpose, every taste, every whim, and every pocketbook, always at money-saving discounts.

Other Lines

Besides a complete radio line, BARAWIK gives you the opportunity to buy, at big savings, auto tires, parts and accessories, sporting goods, electrical and wiring material, electrical household appliances, golf equipment and many of the things that are necessities for every man and in every home. Don't pass up the chance to save money on the many every-day needs offered you by BARAWIK.



SPECIAL SERVICE TO AMATEURS



The BARAWIK COMPANY is the pioneer radio house in supplying short wave equipment, both receivers and transmitters, to amateurs. All the various parts, kits and accessories used in building short wave sets, converters, transmitters, etc., are carried in stock by us, ready for immediate shipment to all parts of the world.

The following Short Wave Circuits are carried in stock by us, ready for immediate delivery to you:

- Aero Coil Kits
- Aero Short Wave Receivers
- Aero Transmitters
- R. E. L. Receivers and Transmitters
- Hammarlund Kits
- Portable Receivers and Transmitters
- Cardwell Parts
- Plus Kits

- Ellis Coils
- National Parts and Receivers
- Karas Parts and Receivers
- Short Wave Converters
- Public Address Systems
- Television Equipment
- Etc., Etc., Etc.

BARAWIK CO., 347 Canal Station, Chicago, Ill.

Dear Sirs:

Please send me your Big Bargain Book showing the Radio Products line and the many bargains in radio goods, sporting goods and the new lines for 1929 that you advertise.

Name

Address

City State

The Barawik Co.

347 Canal Station
Chicago Ill.

THE NEW

Seven Seas Console

First With A-C Shield Grid Tubes

ONCE again Leutz leads, introducing the first A/C Console to use the superior A C Shield Grid Tubes. The result—a superior Console which will meet all competition. 100% shielding, wide spacing between radio frequency transformers and metal and unit construction contribute to make up the finest in radio for the coming season—the new Seven Seas Console by Leutz.

Unit Construction

THE electrical equipment is divided into four separate units: 1, chassis; 2, power amplifier; 3, power pack; 4, dynamic loud speaker. Two 210 tubes in the push-pull amplifier. Three A/C Screen Grid Tubes in the radio frequency amplifier. All heater tubes including one in the detector circuit and one in the first audio stage and a full wave rectifier using two 281 tubes. Here is a radio into which are incorporated the new features of 1930 radio with an unusually perfect audio amplifier. Highest quality dynamic speaker used.

A RADIO that defies competition. A sales leader for the dealer who wants something better than the ordinary to sell. Investigate the Seven Seas Console by Leutz.



Features:

A/C Operation
Single Dial
Dynamic Speaker
Push-Pull Audio
2 210 Power Tubes
100% Shielding
Adjustable Selectivity
Shield Grid Tubes
Heater Type Tubes
Unit Construction
9 Tubes
Maximum Range
Tremendous Volume
Perfect Reproduction
Walnut Console

FRANCHISE APPLICATIONS ARE INVITED

from established dealers

LITERATURE ON REQUEST

C. R. LEUTZ,

Long Island City, New York

CABLES: "Experinfo" New

West Coast Representative: B. J. HOWDERSHELL, Detroit, Mich.

Announcing

a NEW Radio Thrill!

The Super-Wasp Kit combines in one receiver Short-Wave AND Broadcast Reception from 14 to 500 meters.

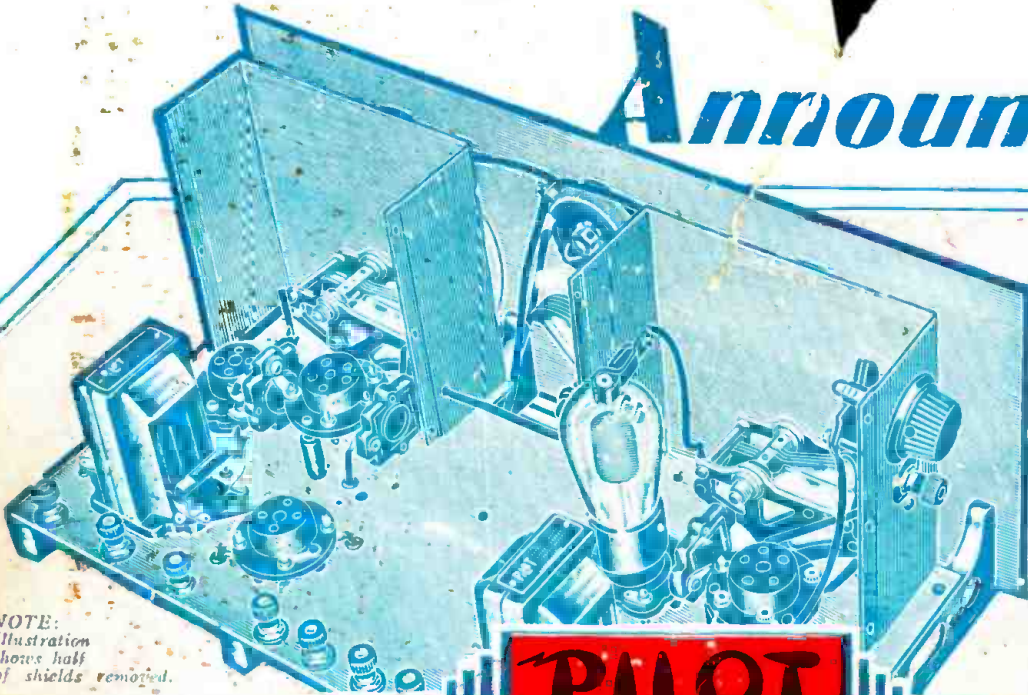

NOTE: Illustration shows half of shields removed.

Assemble it and hear it the same evening!

**PILOT
DOUBLE-DUTY**

SHORT-WAVE BAND BROADCAST BAND

SUPER WASP

TUNED SCREEN GRID 14 TO 500 METERS

Check These FEATURES

Designed and developed by Robt. S. Kruse, the Super-Wasp covers 14 to 500 meters, making it a splendid broadcast receiver as well as a most complete short-wave set.

plug-in coils are

have Receiver mounted R.F. giving and, Se-

per-etal

The Super-Wasp shifts from short wave to broadcast band as quickly as you shift from one speed to another in your car!

When America signs off, international short-wave broadcasts open a whole new world of entertainment. With your Super-Wasp you hop from continent to continent! Distance dissolves and you bring in 10,000 miles as easily as you now bring in locals!

Remember, this four-tube wonder not only brings in the four corners of the earth, but is in addition a splendid super-sensitive broadcast receiver!

More Features

No A.C. Hum pick-up. Completely shielded R.F. and Detector Stages eliminate hand de-tuning effects.

Low losses—ingenious design reduces all R.F. connections to one and a half inches or less!

Illuminated Vernier Dials for both condensers.

Simplicity of assembly due to "sectional cans" and minimum wiring. Assemble and operate it same evening!

On very first test received loud and clear broadcast programs from Chelmsford, England; Costa Rica, Central America; PCJ Eindhoven, Holland; Manitoba, Canada, etc.

PILOT SUPER-WASP KIT

(Catalog No. K-110)
Including 2 sets of 5 coils each, full-sized blue-print and complete assembly data.

\$29.50

Slightly higher west of the Rockies.

SEND FOR RADIO DESIGN

50c brings you one year's subscription to "Radio Design" Quarterly Magazine, chock-full of latest Radio, Short-Wave and Television Developments. "Radio Design," 103-B Broadway, Brooklyn, N.Y.

If There Is No Pilot Dealer In Your Locality, Write Us

IS MADE IN WORLD'S LARGEST RADIO PARTS PLANT!

ELECTRIC MFG. CO.

103-B BROADWAY, BROOKLYN, N.Y. INC.



ESTABLISHED 1926 TRADE MARK REG.